

TGM7

series

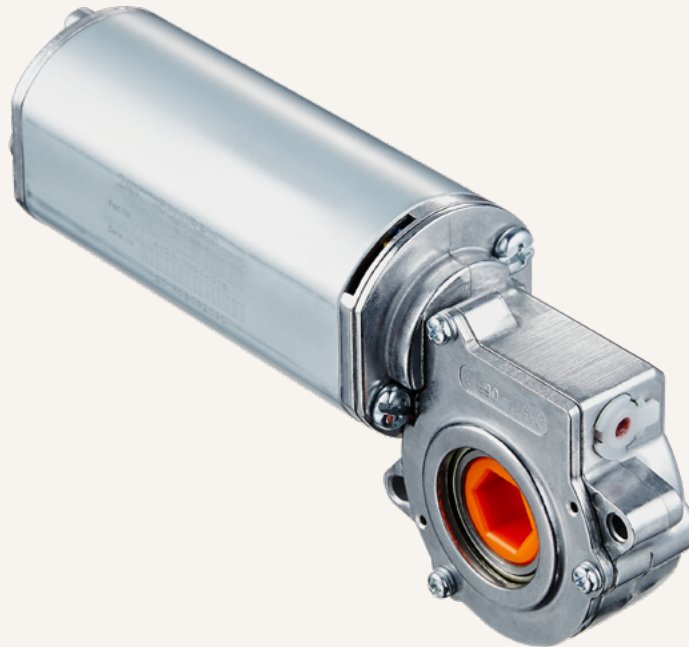

Product Segments

- **Ergo Motion**
- **Industrial Motion**

The TGM7 series is TiMOTION's compact size gear motor. It was designed primarily for ergonomic applications like height adjustable workstations and tables, but can be used in many other applications. This economical product allows for fast, smooth and quiet adjustment of built-in spindles through the use of external limit switches. Shafting allows for the mechanical synchronization of dual spindles.

General Features

Voltage of motor	24V DC
Maximum speed at full load	156RPM (±5%) after gear reduction
Maximum rated torque	7.2Nm
Operational temperature range at full performance	+5°C~+45°C
Options	Hall sensors
Low noise	

Drawing

Standard Dimensions
(mm)

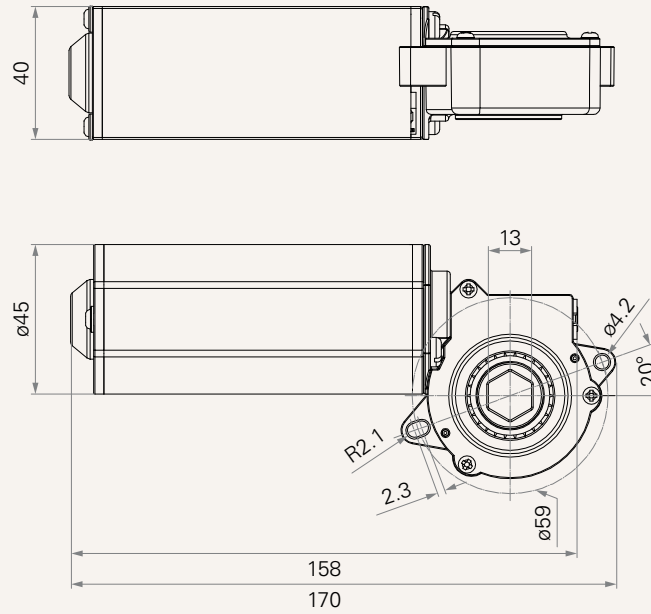

Load and Speed

CODE	Torque Load (Nm)	Self Locking Force (Nm)	Typical Current (A)		Typical Speed (RPM, ±5%)		Hall Sensor Output		
			No Load	With Load	No Load	With Load	Magnet Poles	Period (ms)	
			32V DC	24V DC	32V DC	24V DC		No Load 32V DC	With Load 24V DC
Motor Speed (5200RPM)									
C	7.2	2.9	1.0	6.0	178	78	2	7.9-8.5	17.9-19.7
D	3.6	0.7	1.0	6.0	355	156	2	7.9-8.5	17.9-19.7

Note

- 1 Please refer to the approved drawing for the final authentic value.
- 2 The current & speed in table and diagram are tested with TiMOTION control boxes, and there will be around 10% tolerance depending on different models of the control box. (Under no load condition, the voltage is around 32V DC. At rated load, the voltage output will be around 24V DC)

Performance Data (24V DC Motor)

Motor Speed (5200RPM)

Speed vs. Torque Load

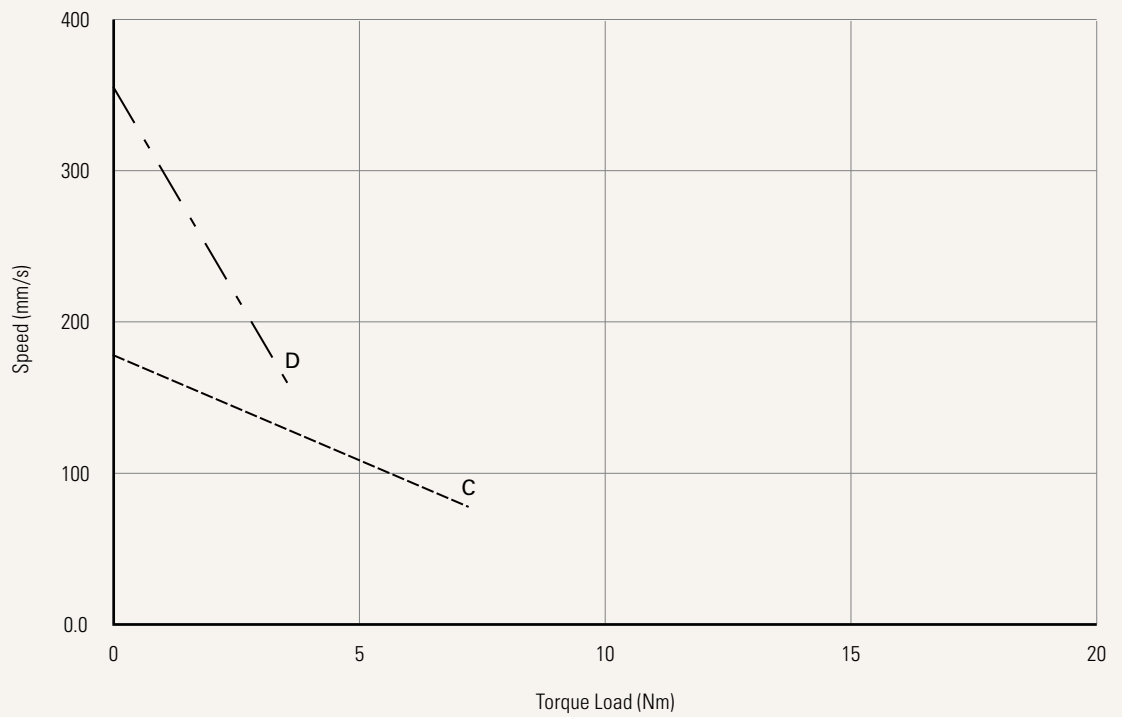

Current vs. Torque Load

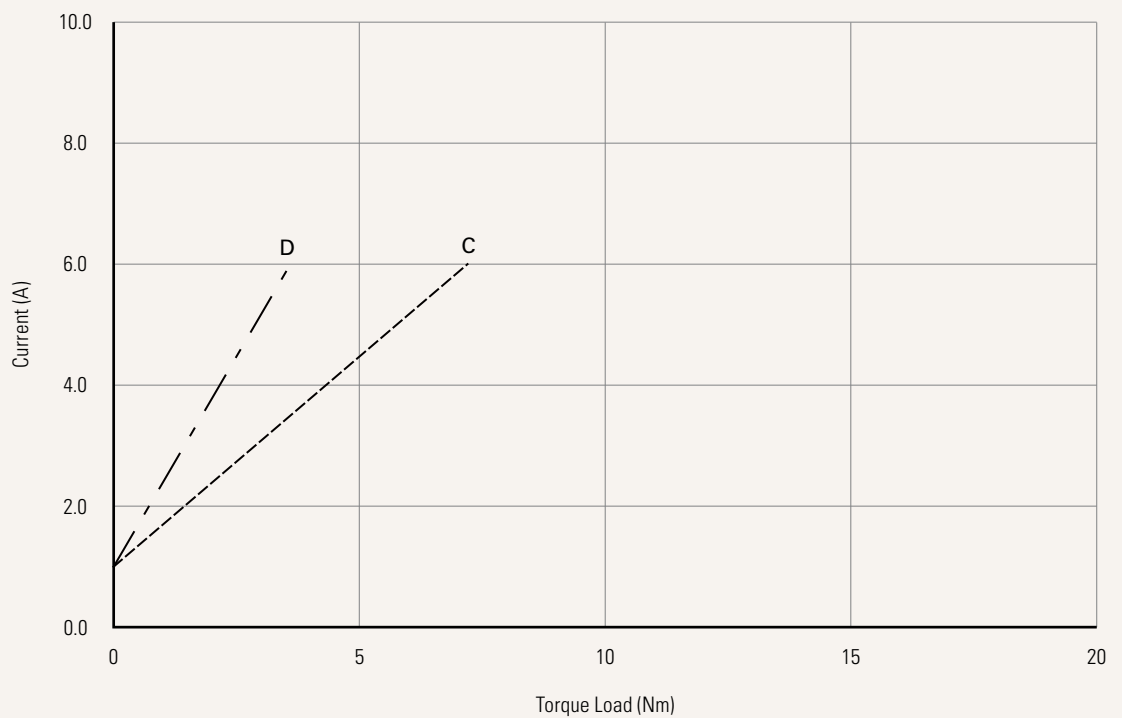

TGM7

Version: 20181122-E

Voltage 2 = 24V

Load and Speed [See page 2](#)

Output Signal 0 = Without 2 = Hall sensor * 2

Brake 0 = Without 1 = Motor brake

Plug 0 = Tinned leads 1 = DIN 6P, 90° 2 = Molex 8P
[See page 5](#)

Cable Length (mm) 0 = Straight, 1000 1 = Straight, 1500 2 = Straight, 2000 3 = Curly, 1000

Plug

0 = Tinned leads

1 = DIN 6P, 90° plug

2 = MOLEX 8P, plug

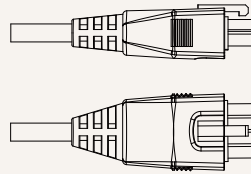
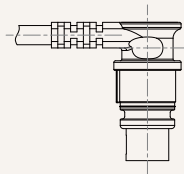
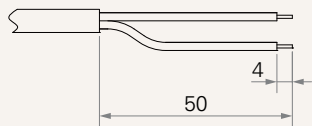

TBS Series - the combination of TGM and TBS

TBS	Input Torque	TGM				
		TGM1	TGM2	TGM3	TGM4	TGM7
TBS1	#1	V	V	V	V	-
TBS2	#1	-	-	-	-	V
TBS3	#1	-	-	-	-	V
TBS4	#1	V	V	V	V	-
TBS5	#1	V	V	V	V	-
TBS9	#1	V	V	V	V	-
TBS10	#1	V	V	V	V	-

Note

- The combinations of TGM and TBS are marked as "v" on the above table.
- When choosing the combination of TBS2 / 3 and TGM7, the hexagonal drive shaft is not required.
- When choosing the combination of TBS1 / 4 / 5 / 9 / 10 and TGM1 / 3 / 4, the extra order of hexagonal drive shaft is needed.
- Please refer to the table below for the serial numbers and the dimensions of the component.

Hexagonal drive shaft

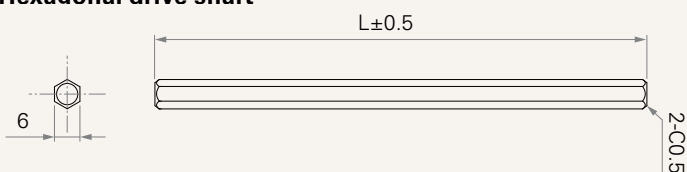

CODE	L (mm)
32709-0101-175-1	175
32709-0101-200-1	200
32709-0101-270-1	270
32709-0101-375-1	375
32709-0101-470-1	470
32709-0101-570-1	570

Terms of Use

The user is responsible for determining the suitability of TiMOTION products for a specific application. TiMOTION products are subject to change without prior notice.