

# TA37

## series

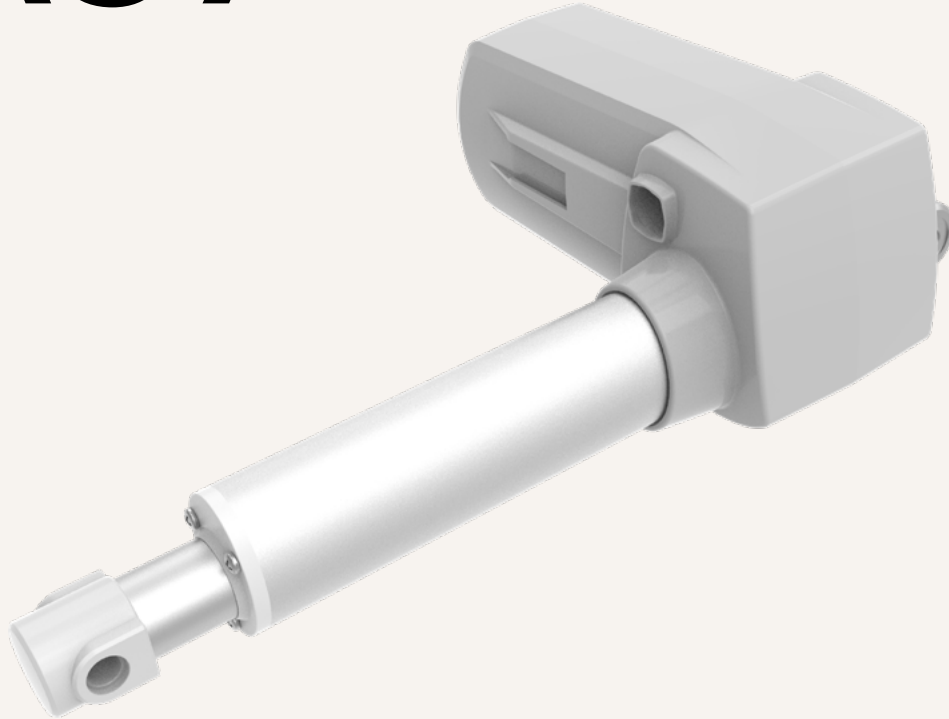

### Product Segments

- **Care Motion**

TA37 is one of our high quality medical actuators. TA37 is recommended for the demanding force medical applications. It remains stable speed even under heavy loading. The maximum stroke of TA37 is up to 1000mm and its IP rating can support up to IP66W. The suitable medical applications for TA37 are treatment tables or patient hoist systems.

#### General Features

Voltage of motor	24, 36V DC (thermal protector)
Maximum load	12,000N in push
Maximum speed at full load	18mm/s (with 4000N in a push condition)
Stroke	≥ 25~1000mm
Minimum installation dimension	≥ Stroke +170mm
Color	Black or grey
IP Rating	Up to IP66W
Operational temperature range	+5°C~+45°C
Options	Hall sensor(s), manual release (for patient hoist)
Certificate	IEC60601-1
Suitable for patient hoist application	

**Drawing**

Standard Dimensions  
(mm)

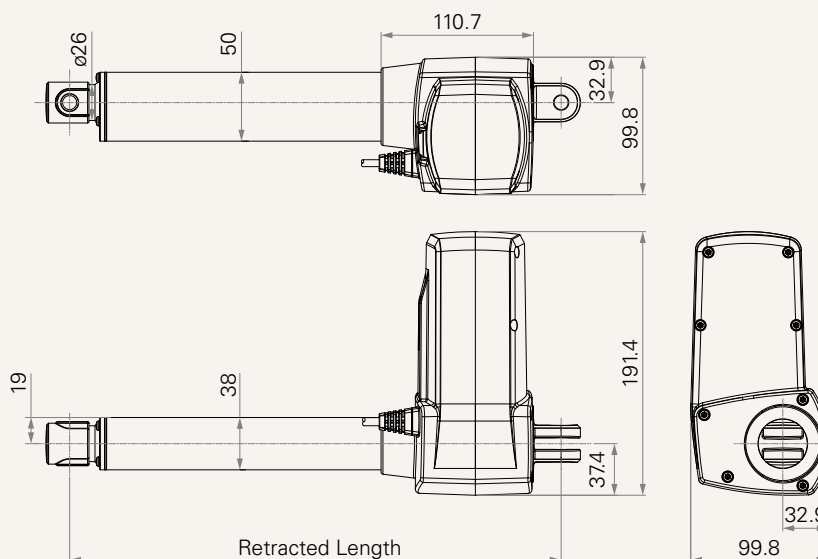

**Load and Speed**

CODE	Load (N) Push	Self Locking Force (N)	Typical Current (A)		Typical Speed (mm/s)	
			No Load 32V DC	With Load 24V DC	No Load 32V DC	With Load 24V DC
<b>Motor Speed (4100RPM, duty cycle 10%)</b>						
<b>B</b>	4000	4000	2.0	8.0	31.1	18.0
<b>C</b>	6000	6000	2.0	10.0	23.1	13.3
<b>D</b>	8000	8000	2.0	8.4	13.3	8.3
<b>E</b>	10000	10000	2.0	9.2	11.5	7.0
<b>F</b>	12000	12000	2.0	9.2	8.7	5.3

**Note**

- 1 Please refer to the approved drawing for the final authentic value.
- 2 Max static pull load 4,000N, dynamic pull not allowed.
- 3 This self-locking force level is reached only when a short circuit is applied on the terminals of the motor. All the TiMOTION control boxes have this feature built-in.
- 4 The current & speed in table are tested with 24V DC motor. With a 12V DC motor, the current is approximately twice the current measured in 24V DC. With a 36V DC motor, the current is approximately two-thirds the current measured in 24V DC. Speed will be similar for all the voltages.
- 5 The current & speed in table are tested when the actuator is extending under push load.
- 6 The current & speed in table and diagram are tested with TiMOTION control boxes, and there will be around 10% tolerance depending on different models of the control box. (Under no load condition, the voltage is around 32V DC. At rated load, the voltage output will be around 24V DC)
- 7 Standard stroke: Min.  $\geq 25$ mm, Max. please refer to below table.

CODE	Load (N)	Max Stroke (mm)
<b>B</b>	4000	1000
<b>C</b>	6000	900
<b>D</b>	8000	800
<b>E</b>	10000	650
<b>F</b>	12000	450

**Performance Data (24V DC)**

Motor Speed (4100RPM, duty cycle 10%)

Speed vs. Load

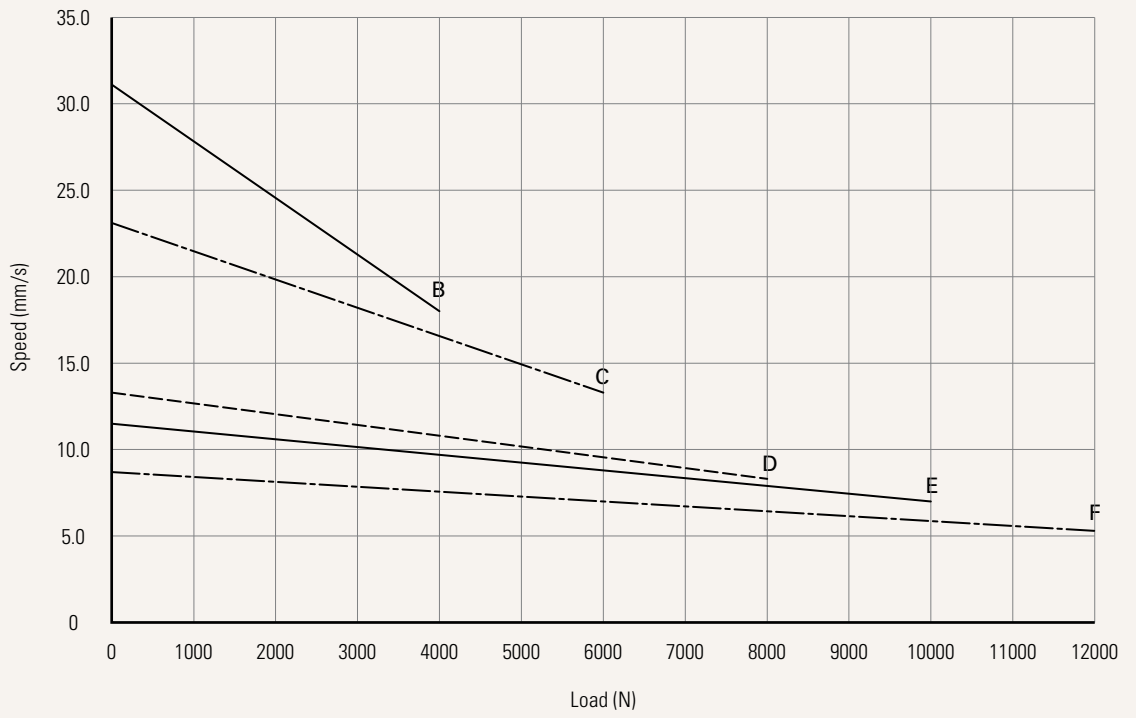

Current vs. Load

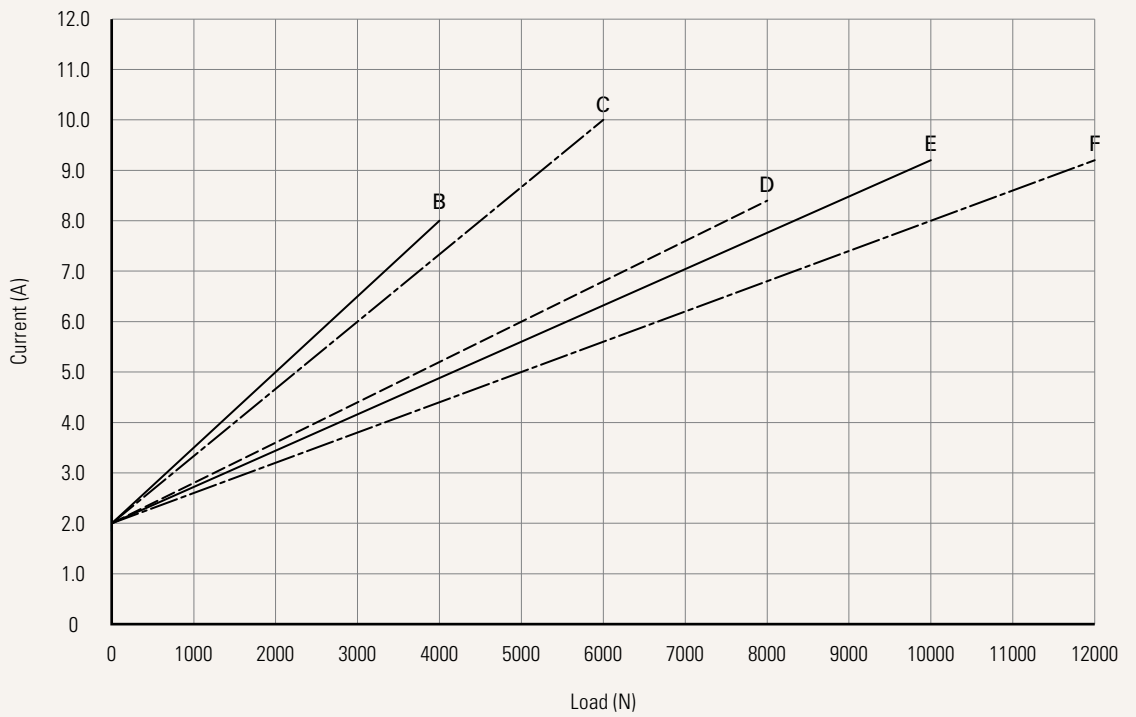

<b>Voltage</b>	5 = 24V DC, thermal protector	7 = 36V DC, thermal protector		
<b>Load and Speed</b>	<a href="#">See page 2</a>			
<b>Stroke (mm)</b>	<a href="#">See page 2</a>			
<b>Retracted Length (mm)</b>	<a href="#">See page 6</a>			
<b>Rear Attachment (mm)</b>	1 = Aluminum casting, U clevis, slot 6.2, depth 19.5, hole 10.2 <a href="#">See page 6</a>	4 = Aluminum casting, U clevis, slot 8.2, depth 19.5, hole 12.2 C = Aluminum casting, U clevis, slot 8.2, depth 19.5, hole 10.2, with plastic T-busing		
<b>Front Attachment (mm)</b>	2 = Aluminum casting, U clevis, slot 6.2, depth 19.5, hole 12.2 3 = Aluminum casting, U clevis, slot 8.2, depth 19.5, hole 10.2 <a href="#">See page 7</a>	9 = Aluminum casting, U clevis, slot 6.2, depth 17.0, hole 10.2, with plastic T-bushing K = Aluminum casting, U clevis, slot 8.2, depth 17.0, hole 10.2 L = Aluminum casting, U clevis, slot 8.2, depth 17.0, hole 12.2 M = Aluminum casting, U clevis, slot 8.2, depth 17.0, hole 10.2, with plastic T-bushing		
<b>Direction of Rear Attachment (Counterclockwise)</b>	1 = 0°	3 = 90° <a href="#">See page 7</a>		
<b>Color</b>	1 = Black	2 = Grey (Pantone 428C)		
<b>IP Rating</b>	1 = Without	2 = IP54	3 = IP66	5 = IP66W
<b>Special Functions for Spindle Sub-Assembly</b>	0 = Without (standard) 1 = Safety nut	2 = Standard push only 3 = Standard push only + safety nut		
<b>Functions for Limit Switches</b>	1 = Two switches at full retracted / extended positions to cut current 2 = Two switches at full retracted / extended positions to cut current + third one in between to send signal 3 = Two switches at full retracted / extended positions to send signal 4 = Two switches at full retracted / extended positions to send signal + third one in between to send signal 5 = Two switches at full retracted / extended positions to send signal (For TC1, TC8, TC10, TC14, TC21) <a href="#">See page 8</a>			
<b>Output Signals</b>	0 = Without	1 = Hall sensor * 1	2 = Hall sensor * 2	
<b>Connector</b>	1 = DIN 6P, 90° plug <a href="#">See page 8</a>	4 = Big 01P, plug E = Molex 8P, plug	F = DIN 6P, 180° plug G = Audio plug	
<b>Cable Length (mm)</b>	0 = Straight, 100 1 = Straight, 500 2 = Straight, 750	3 = Straight, 1000 4 = Straight, 1250 5 = Straight, 1500	6 = Straight, 2000 7 = Curly, 200 8 = Curly, 400	

### Note

1 TA37 is designed especially for push applications, not suitable for pull applications.

# TA37 Patient Hoist Ordering Key

TA37

Version: 20190425-E

<b>Voltage</b>	5 = 24V DC, thermal protector	7 = 36V DC, thermal protector		
<b>Load and Speed</b>	E = 10000N	F = 12000N		
<b>Stroke (mm)</b>	<a href="#">See page 2</a>			
<b>Retracted Length (mm)</b>	<a href="#">See page 6</a>			
<b>Rear Attachment (mm)</b>	C = Aluminum casting, U clevis, slot 8.2, depth 19.5, hole 10.2, with plastic T-busing <a href="#">See page 6</a>			
<b>Front Attachment (mm)</b>	F = Aluminum casting, U clevis, slot 8.2, depth 17.0, hole 10.2, with plastic T-bushing, for Manual Release <a href="#">See page 7</a>			
<b>Direction of Rear Attachment (Counterclockwise)</b>	1 = 0° <a href="#">See page 7</a>			
<b>Color</b>	1 = Black	2 = Grey (Pantone 428C)		
<b>IP Rating</b>	1 = Without	2 = IP54	3 = IP66	5 = IP66W
<b>Special Functions for Spindle Sub-Assembly</b>	6 = Mechanical push only + safety nut			
<b>Functions for Limit Switches</b>	1 = Two switches at full retracted / extended positions to cut current <a href="#">See page 8</a>			
<b>Output Signals</b>	0 = Without			
<b>Connector</b>	1 = DIN 6P, 90° plug	F = DIN 6P, 180° plug	G = Audio plug	
<b>Cable Length (mm)</b>	1 = Straight, 500	3 = Straight, 1000	5 = Straight, 1500	
	2 = Straight, 750	4 = Straight, 1250	6 = Straight, 2000	

## Note

1 TA37 is designed especially for push applications, not suitable for pull applications.

## Retracted Length (mm)

1. Calculate A+B = Y
2. Retracted length needs to  $\geq$  Stroke + Y

A.		
Front Attach.	General	For Patient Hoist
1, 2	170	-
7, 8, 9, K, L, M	178	-
F	-	267

Stroke (mm)	B.					
	Load (N)					
	General					For Patient Hoist
	= 4000	= 6000	= 8000	= 10000	= 12000	
25~150	-	-	-	+5	+10	-
151~200	-	-	+5	+10	+15	-
201~250	-	+5	+10	+15	+20	-
251~300	+5	+10	+15	+20	+25	+5
301~350	+10	+15	+20	+25	+30	+10
351~400	+15	+20	+25	+30	+35	+15
401~450	+20	+25	+30	+35	+40	+20
451~500	+25	+30	+35	+40	+45	+25
501~550	+30	+35	+40	+45	+50	+30
551~600	+35	+40	+45	+50	+55	+35
601~650	+40	+45	+50	+55	+60	+40
651~700	+45	+50	+55	+60	+65	+45
701~750	+50	+55	+60	+65	+70	+50
751~800	+55	+60	+65	+70	+75	+55
801~850	+60	+65	+70	+75	+80	+60
851~900	+65	+70	+75	+80	+85	+65
901~950	+70	+75	+80	+85	+90	+70
951~1000	+75	+80	+85	+90	+95	+75

## Rear Attachment (mm)

1 = Aluminum casting, U clevis, slot 6.2, depth 19.5, hole 10.2

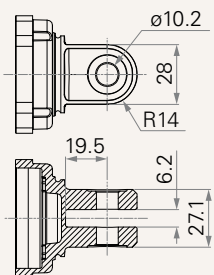

2 = Aluminum casting, U clevis, slot 6.2, depth 19.5, hole 12.2

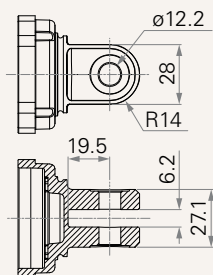

3 = Aluminum casting, U clevis, slot 8.2, depth 19.5, hole 10.2

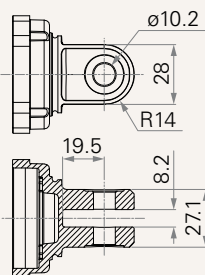

4 = Aluminum casting, U clevis, slot 8.2, depth 19.5, hole 12.2

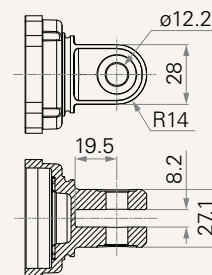

C = Aluminum casting, U clevis, slot 8.2, depth 19.5, hole 10.2, with plastic T-busing

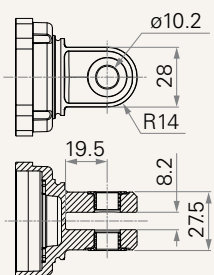

## Front Attachment (mm)

1 = Punched hole on inner tube + plastic cap, without slot, hole 10.2, with plastic bush

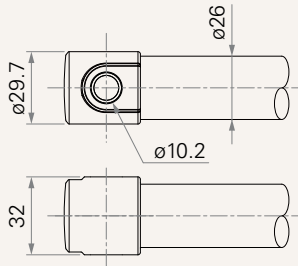

2 = Punched hole on inner tube + plastic cap, without slot, hole 12.2

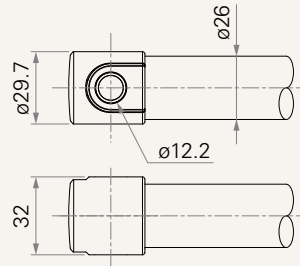

7 = Aluminum casting, U clevis, slot 6.2, depth 17.0, hole 10.2

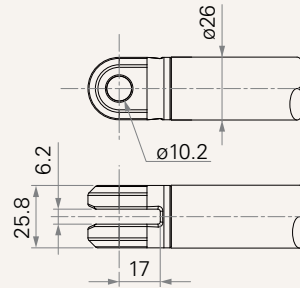

8 = Aluminum casting, U clevis, slot 6.2, depth 17.0, hole 12.2

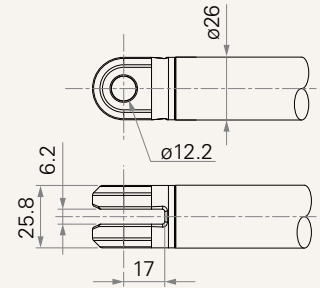

9 = Aluminum casting, U clevis, slot 6.2, depth 17.0, hole 10.2, with plastic T-bushing

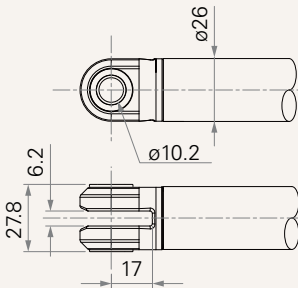

K = Aluminum casting, U clevis, slot 8.2, depth 17.0, hole 10.2

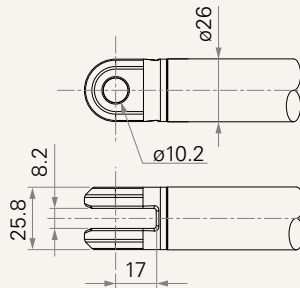

L = Aluminum casting, U clevis, slot 8.2, depth 17.0, hole 12.2

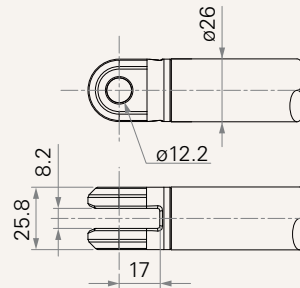

M = Aluminum casting, U clevis, slot 8.2, depth 17.0, hole 10.2, with plastic T-bushing

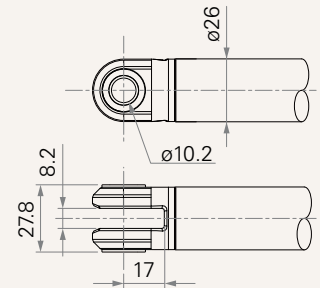

## Direction of Rear Attachment (Counterclockwise)

1 = 0°

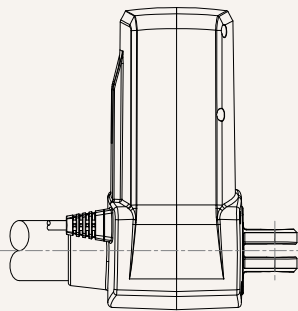

3 = 90°

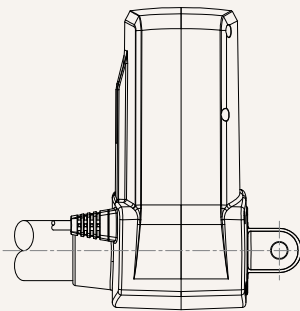

## Functions for Limit Switches

### Wire Definitions

CODE	Pin					
	● 1 (Green)	● 2 (Red)	○ 3 (White)	● 4 (Black)	● 5 (Yellow)	● 6 (Blue)
1	extend (VDC+)	N/A	N/A	N/A	retract (VDC+)	N/A
2	extend (VDC+)	N/A	middle switch pin B	middle switch pin A	retract (VDC+)	N/A
3	extend (VDC+)	common	upper limit switch	N/A	retract (VDC+)	lower limit switch
4	extend (VDC+)	common	upper limit switch	medium limit switch	retract (VDC+)	lower limit switch
5	extend (VDC+)	N/A	upper limit switch	common	retract (VDC+)	lower limit switch

### Connector

1 = DIN 6P, 90° plug

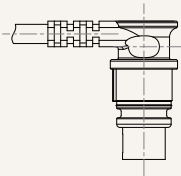

2 = Tinned leads

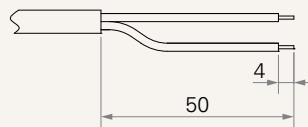

4 = Big 01P, plug

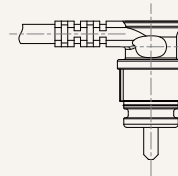

E = Molex 8P, plug

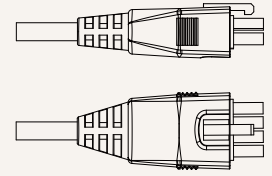

F = DIN 6P, 180° plug

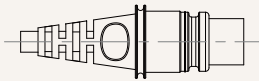

G = Audio plug

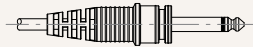

### Terms of Use

The user is responsible for determining the suitability of TiMOTION products for a specific application. TiMOTION products are subject to change without prior notice.