

TA36

series

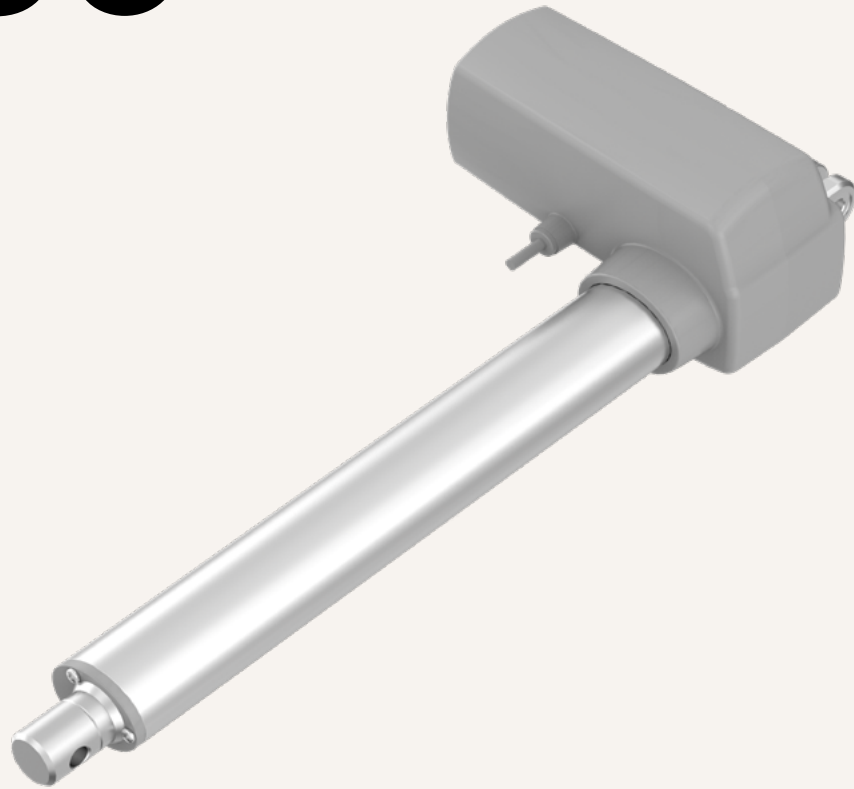

Product Segments

- **Care Motion**

TA36 is one of our new generation medical actuators. It can lift up to 10000N and its IP rating is up to IP66W. The zero backlash design is stable and can be applied to various medical applications. The TA36 is suitable for operating beds or high-load patient lift systems.

General Features

Voltage of motor	12, 24, 36V DC, 24V DC (PTC)
Maximum load	10,000N in push
Maximum load	6,000N in pull
Maximum speed at full load	8mm/s (with 6,000N in a push or pull condition)
Stroke	25~600mm
Minimum installation dimension	≥ Stroke + 170mm
Color	Black or grey
IP Rating	Up to IP66W
Operational temperature range at full performance	+5°C~+45°C
Options	Hall sensors, manual release (for patient hoist)
Certificate	IEC60601-1, ES60601-1, IEC60601-1-2
Suitable for patient hoist application	

Drawing

Standard Dimensions
(mm)

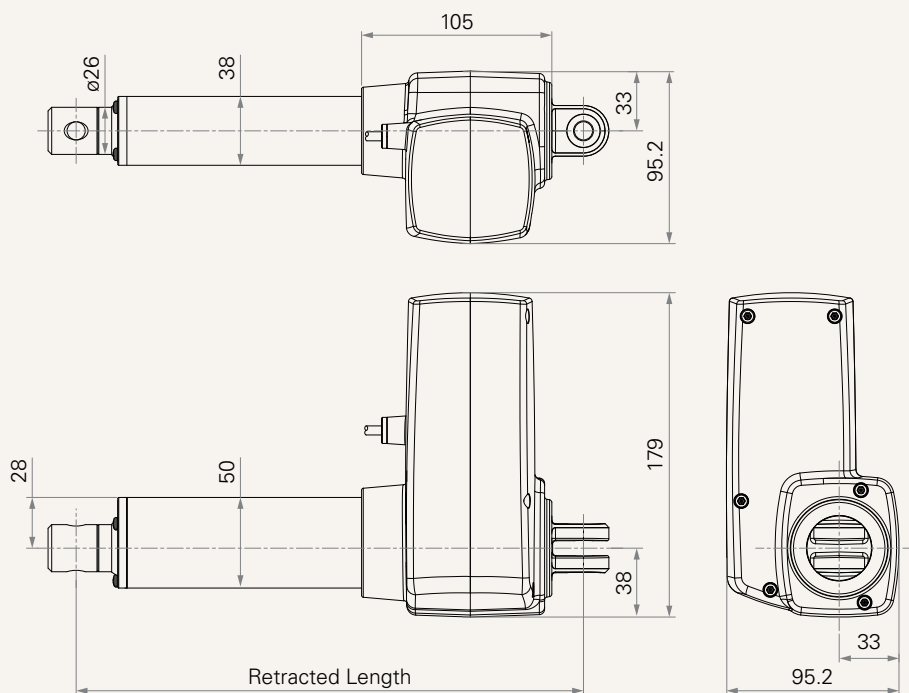

Load and Speed

CODE	Load (N)		Self Locking Force (N)	Typical Current (A)		Typical Speed (mm/s)	
	Push	Pull		No Load 32V DC	With Load 24V DC	No Load 32V DC	With Load 24V DC
Motor Speed (4300RPM long motor, Duty cycle 10%)							
B	6000	6000	6000	1.5	6.0	13.9	8.0
C	8000	6000	8000	1.5	7.8	11.9	7.0
D	10000	6000	10000	1.5	9.8	10.3	5.4
E	10000	6000	10000	1.5	6.0	6.0	3.9

Note

- 1 Please refer to the approved drawing for the final authentic value.
- 2 This self-locking force level is reached only when a short circuit is applied on the terminals of the motor. All the TiMOTION control boxes have this feature built-in.
- 3 The current & speed in table are tested when the actuator is extending under push load.
- 4 The current & speed in table and diagram are tested with TiMOTION control boxes, and there will be around 10% tolerance depending on different models of the control box. (Under no load condition, the voltage is around 32V DC. At rated load, the voltage output will be around 24V DC)
- 5 Standard stroke: Min. ≥ 25mm, Max. please refer to below table.

CODE	Load (N)	Max Stroke (mm)
C, D, E	≥ 8000	450
B	= 6000	600

Performance Data (24V DC Motor)

Motor Speed (4300RPM long motor, Duty cycle 10%)

Speed vs. Load

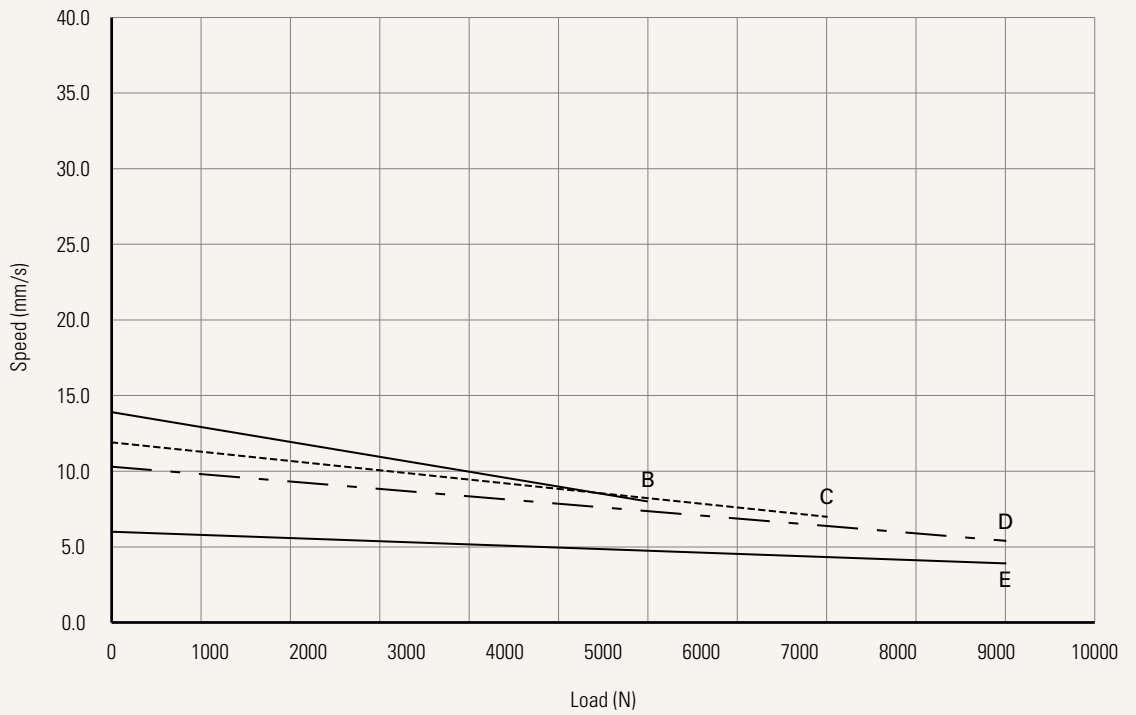

Current vs. Load

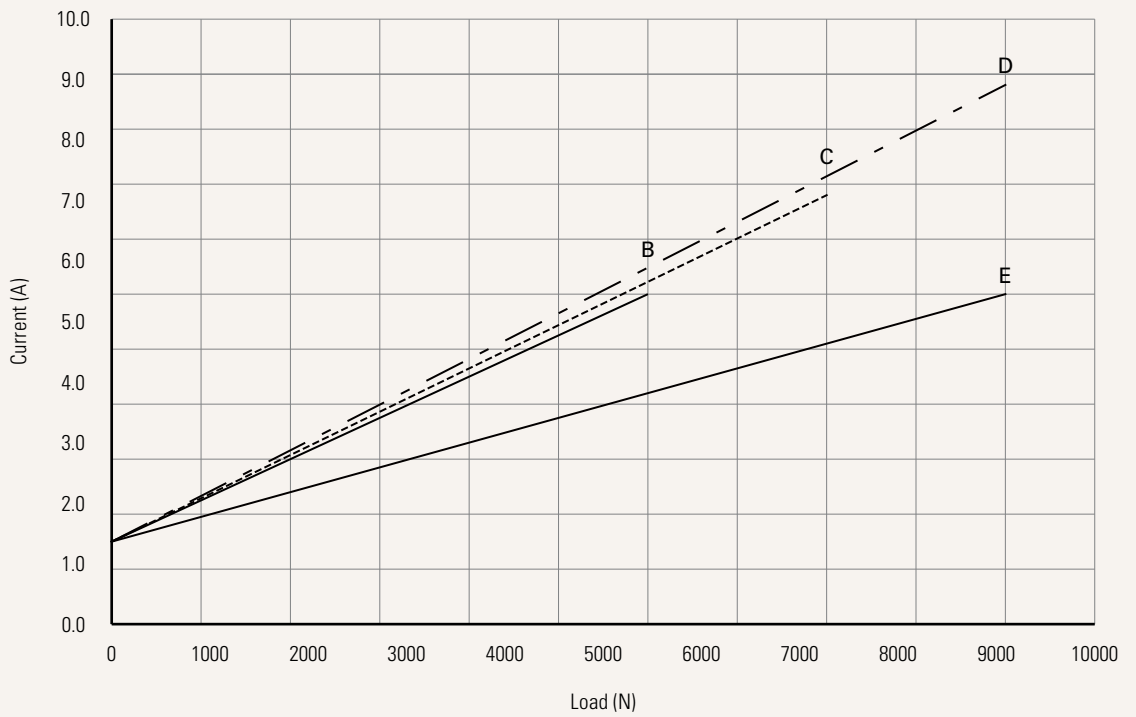

TA36 Zero Backlash Ordering Key

TA36

Version: 2019008-H

Voltage	1 = 12V DC	2 = 24V DC	3 = 36V DC	5 = 24V DC, PTC
Load and Speed	C = 8000N	E = 10000N		
Stroke (mm)				
Retracted Length (mm)	See page 7			
Rear Attachment (mm) See page 8	1 = Aluminum casting, no slot, hole 10.0 2 = Aluminum casting, no slot, hole 12.0 5 = Aluminum casting, clevis U, slot 6.2, depth 17.0, hole 10.0 6 = Aluminum casting, clevis U, slot 6.2, depth 17.0, hole 12.0		7 = Aluminum casting, clevis U, slot 8.2, depth 17.0, hole 10.0 8 = Aluminum casting, clevis U, slot 8.2, depth 17.0, hole 12.0	
Front Attachment (mm) See page 8	1 = Aluminum CNC, no slot, hole 10.0 2 = Aluminum CNC, no slot, hole 12.0 5 = Iron CNC, clevis U, slot 6.2, depth 17.0, hole 10.0 6 = Iron CNC, clevis U, slot 6.2, depth 17.0, hole 12.0		7 = Iron CNC, clevis U, slot 8.2, depth 17.0, hole 10.0 8 = Iron CNC, clevis U, slot 8.2, depth 17.0, hole 12.0 K = Iron, rod end bearing, no slot, hole 10.0	
Direction of Rear Attachment (Counterclockwise) See page 9	1 = 0°	3 = 90°		
Color	1 = Black	2 = Grey (Pantone 428C)		
IP Rating	1 = Without	2 = IP54	3 = IP66	5 = IP66W
Special Functions for Spindle Sub-Assembly	0 = Without (Standard)	1 = Safety nut		
Functions for Limit Switches See page 9	1 = Two switches at full retracted / extended positions to cut current 2 = Two switches at full retracted / extended positions to cut current + third one in between to send signal 3 = Two switches at full retracted / extended positions to send signal 4 = Two switches at full retracted / extended positions to send signal + third one in between to send signal 5 = Two switches at full retracted / extended positions to send signal (Operate with control box: TC1, TC8, TC10, TC14, TC21; compatible with hall sensors)			
Output Signals	0 = Without	2 = Hall sensor*2		
Connector See page 10	1 = DIN 6P, 90° plug 2 = Tinned leads 4 = Big 01P, plug	E = Molex 8P, plug F = DIN 6P, 180° plug, for TEC extension cable standard option	G = Audio plug	
Cable Length (mm)	0 = Straight, 100 1 = Straight, 500 2 = Straight, 750	3 = Straight, 1000 4 = Straight, 1250 5 = Straight, 1500	6 = Straight, 2000 7 = Curly, 200 8 = Curly, 400	

TA36 Standard Version Ordering Key

TA36

Version: 2019008-H

Voltage	1 = 12V DC	2 = 24V DC	3 = 36V DC	5 = 24V DC, PTC
Load and Speed	See page 2			
Stroke (mm)				
Retracted Length (mm)	See page 7			
Rear Attachment (mm)	C = Aluminum casting, clevis U, slot 8.2, depth 17.0, hole 10.2, with plastic T-bushing			
	See page 8			
Front Attachment (mm)	B = Aluminum casting, clevis U, slot 6.2, depth 17.0, hole 12.2 C = Aluminum casting, clevis U, slot 6.2, depth 17.0, hole 10.2, with plastic T-bushing			
	See page 8			
Direction of Rear Attachment (Counterclockwise)	1 = 0°	3 = 90°		
	See page 9			
Color	1 = Black	2 = Grey (Pantone 428C)		
IP Rating	1 = Without	2 = IP54	3 = IP66	5 = IP66W
Special Functions for Spindle Sub-Assembly	0 = Without (Standard) 1 = Safety nut		2 = Standard push only 3 = Standard push only + safety nut	
Functions for Limit Switches	1 = Two switches at full retracted / extended positions to cut current 2 = Two switches at full retracted / extended positions to cut current + third one in between to send signal 3 = Two switches at full retracted / extended positions to send signal 4 = Two switches at full retracted / extended positions to send signal + third one in between to send signal 5 = Two switches at full retracted/extended positions to send signal (Operate with control box: TC1, TC8, TC10, TC14, TC21; compatible with hall sensors)			
	See page 9			
Output Signals	0 = Without	2 = Hall sensor*2		
Connector	1 = DIN 6P, 90° plug 2 = Tinned leads 4 = Big 01P, plug	E = Molex 8P, plug F = DIN 6P, 180° plug, for TEC extension cable standard option	G = Audio plug	
	See page 10			
Cable Length (mm)	0 = Straight, 100 1 = Straight, 500 2 = Straight, 750	3 = Straight, 1000 4 = Straight, 1250 5 = Straight, 1500	6 = Straight, 2000 7 = Curly, 200 8 = Curly, 400	

TA36 Patient Hoist Ordering Key

TA36

Version: 2019008-H

Voltage	2 = 24V DC	5 = 24V DC, PTC		
Load and Speed	See page 2			
Stroke (mm)				
Retracted Length (mm)	See page 7			
Rear Attachment (mm)	C = Aluminum casting, clevis U, slot 8.2, depth 17.0, hole 10.2, with plastic T-bushing			
	See page 8			
Front Attachment (mm)	F = Aluminum casting, clevis U, slot 8.2, depth 19.0, hole 10.2, T-bushing, for Manual Release			
	See page 8			
Direction of Rear Attachment (Counterclockwise)	1 = 0°			
	See page 9			
Color	1 = Black	2 = Grey (Pantone 428C)		
IP Rating	1 = Without	2 = IP54	3 = IP66	5 = IP66W
Special Functions for Spindle Sub-Assembly	6 = Mechanical push only + safety nut			
Functions for Limit Switches	1 = Two switches at full retracted / extended positions to cut current			
	See page 9			
Output Signals	0 = Without			
Connector	1 = DIN 6P, 90° plug	G = Audio plug		
	See page 10			
	F = DIN 6P, 180° plug, for TEC extension cable standard option			
Cable Length (mm)	1 = Straight, 500	3 = Straight, 1000	5 = Straight, 1500	
	2 = Straight, 750	4 = Straight, 1250	6 = Straight, 2000	

Retracted Length (mm)

1. Calculate $A+B = Y$
2. Retracted length needs to \geq Stroke + Y

A. Front Attachment		
CODE		Patient Hoist
1, 2	+170	-
5, 6, 7, 8	+180	-
B, C	+182	-
K	+182	-
F	-	+253

B. Load V.S. Stroke				
Stroke (mm)	Load (N)			Patient Hoist
	General			
	B	C	D, E	
25~150	-	-	+5	-
151~200	-	+5	+10	-
201~250	+5	+10	+15	-
251~300	+10	+15	+20	+5
301~350	+15	+20	+25	+10
351~400	+20	+25	+30	+15
401~450	+25	+30	+35	+20
451~500	+30	+35	+40	+25
501~550	+35	+40	+45	+30
551~600	+40	+45	+50	+35
601~650	+45	+50	+55	+40
651~700	+50	+55	-	-
701~750	+55	+60	-	-
751~800	+60	+65	-	-
801~850	+65	-	-	-
851~900	+70	-	-	-

Rear Attachment (mm)

1 = Aluminum casting, no slot, hole 10.0

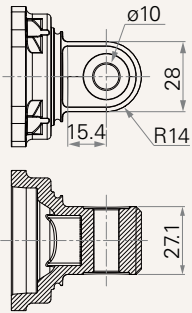

2 = Aluminum casting, no slot, hole 12.0

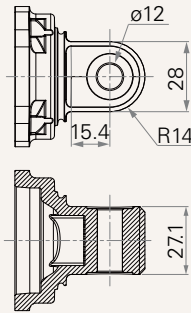

5 = Aluminum casting, clevis U, slot 6.2, depth 17.0, hole 10.0

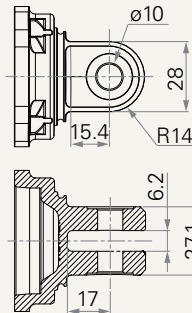

6 = Aluminum casting, clevis U, slot 6.2, depth 17.0, hole 12.0

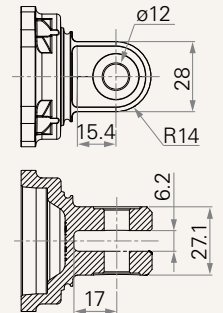

7 = Aluminum casting, clevis U, slot 8.2, depth 17.0, hole 10.0

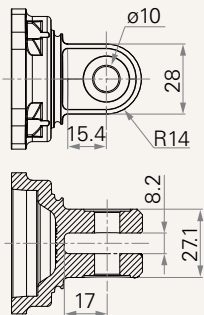

8 = Aluminum casting, clevis U, slot 8.2, depth 17.0, hole 12.0

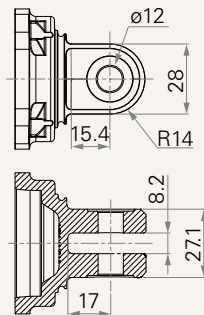

C = Aluminum casting, clevis U, slot 8.2, depth 17.0, hole 10.2, T bush

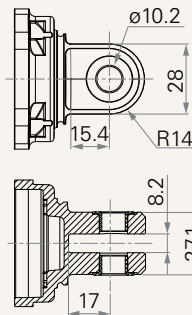

Front Attachment (mm)

1 = Aluminum CNC, no slot, hole 10.0

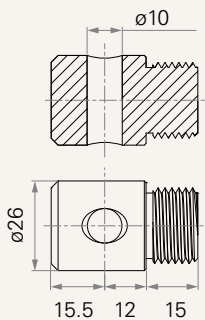

2 = Aluminum CNC, no slot, hole 12.0

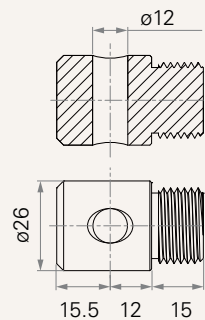

5 = Iron CNC, clevis U, slot 6.2, depth 17.0, hole 10.0

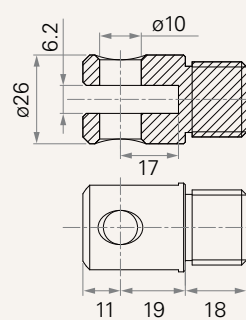

6 = Iron CNC, clevis U, slot 6.2, depth 17.0, hole 12.0

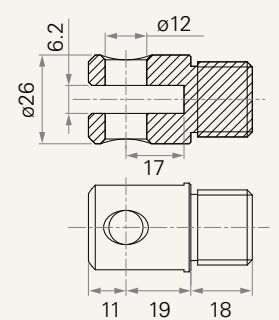

7 = Iron CNC, clevis U, slot 8.2, depth 17.0, hole 10.0

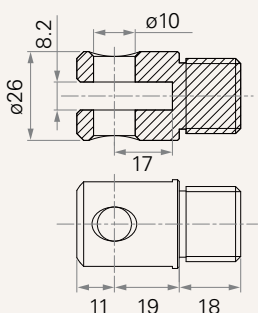

8 = Iron CNC, clevis U, slot 8.2, depth 17.0, hole 12.0

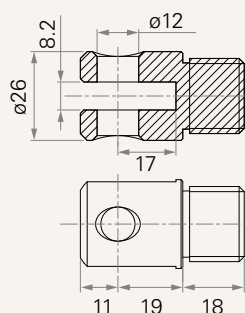

B = Aluminum casting, clevis U, slot 6.2, depth 17.0, hole 12.2

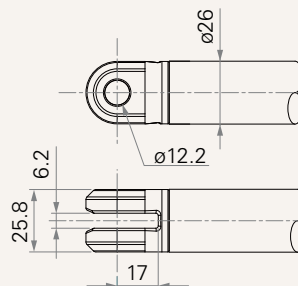

C = Aluminum casting, clevis U, slot 6.2, depth 17.0, hole 10.2, with plastic T-bushing

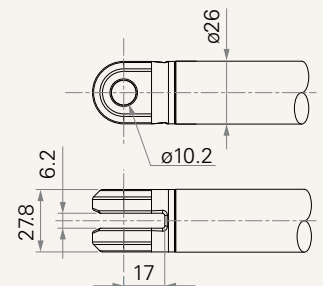

Front Attachment (mm)

K = Iron, rod end bearing, no slot, hole 10.0

F = Aluminum casting, clevis U, slot 8.2, depth 19.0, hole 10.2, T-bushing, for Manual Release

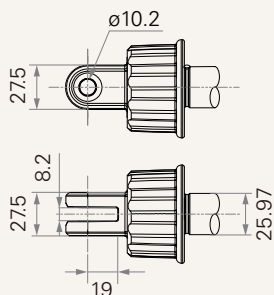
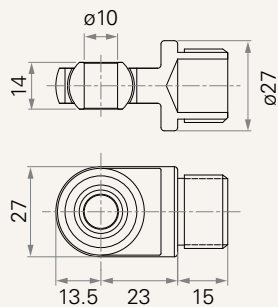

Direction of Rear Attachment (Counterclockwise)

1 = 0°

3 = 90°

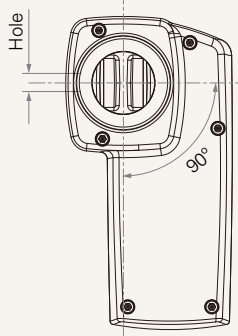
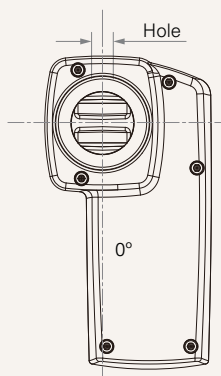

Functions for Limit Switches

Wire Definitions

CODE	Pin	1 (Green)	2 (Red)	3 (White)	4 (Black)	5 (Yellow)	6 (Blue)
1	extend (VDC+)	N/A	N/A	N/A	N/A	retract (VDC+)	N/A
2	extend (VDC+)	N/A	N/A	middle switch pin B	middle switch pin A	retract (VDC+)	N/A
3	extend (VDC+)	common	upper limit switch	N/A	retract (VDC+)	lower limit switch	
4	extend (VDC+)	common	upper limit switch	medium limit switch	retract (VDC+)	lower limit switch	
5	extend (VDC+)	N/A	upper limit switch	common	retract (VDC+)	lower limit switch	

Connector

1 = DIN 6P, 90° plug

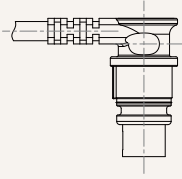

2 = Tinned leads

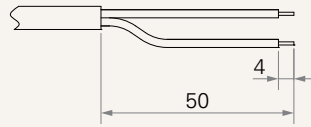

4 = Big 01P, plug

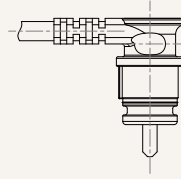

E = Molex 8P, plug

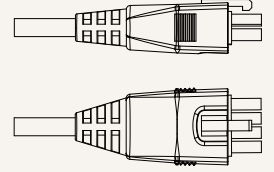

F = DIN 6P, 180° plug, for TEC
extension cable standard option

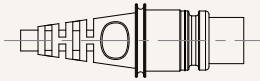

G = Audio plug

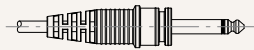

Terms of Use

The user is responsible for determining the suitability of TiMOTION products for a specific application. TiMOTION products are subject to change without prior notice.