

MA2

series



Product Segments

• Industrial Motion

TiMOTION's MA2 series linear actuator was specifically designed for applications which face harsh working environments and require ruggedness and durability. Its IP69K protection ensures it will withstand high pressure water jets, and the ingress of dust and other solid contaminants. The MA2 also has optional Reed switches along the outer tube which allow users to adjust the stroke length. For improved control and accuracy of motion, the MA2 can be customized with many different feedback options depending on your application requirements. Example applications suitable for the MA2: Agricultural equipment such as spreaders, harvesters, grain handlers, combines and tractors.

Commercial and industrial applications such as commercial lawn mowers, scrubbers and sweepers, material handling equipment and livestock ventilation systems.

General Features

Voltage of motor	12V DC, 24V DC, 36V DC; 12V DC, 24V DC, 36V DC (thermal control)
Maximum load	6,000N in push and pull
Maximum speed at full load:	43mm/s (with 1000N in a push or pull condition)
Stroke	≥ 25~1000mm
Minimum installation dimension	≥ Stroke + 131mm
IP rating	Up to IP69K
Certificate	UL73, EMC
Operational temperature range	-25°C~+65°C
Operational temperature range at full performance	+5°C~+45°C
Options	Hall sensors, POT, manual drive, Reed sensor on the outer tube

Drawing

Standard Dimensions
(mm)

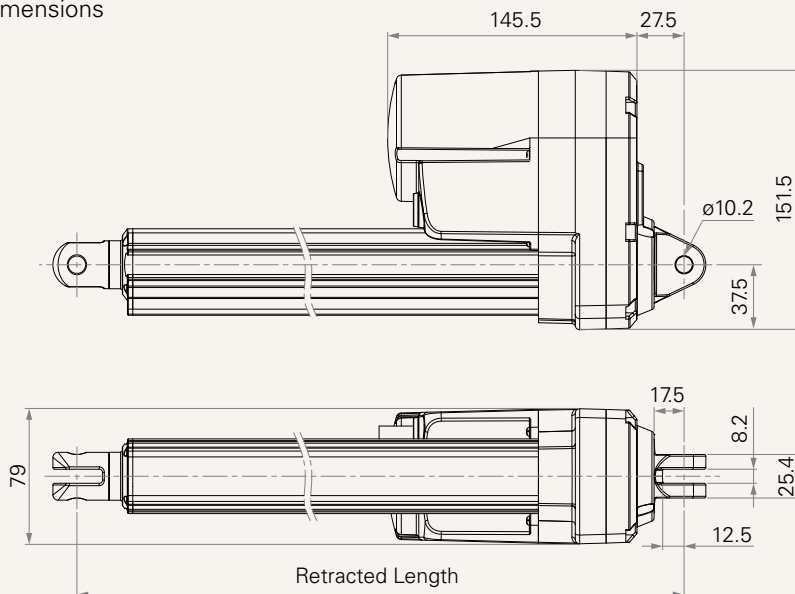

Load and Speed

CODE	Load (N)		Self Locking Force (N)	Typical Current (A)		Typical Speed (mm/s)	
	Push	Pull		No Load 24V DC	With Load 24V DC	No Load 24V DC	With Load 24V DC
Motor Speed (5200RPM, duty cycle 25%)							
F	1000	1000	1000	2.7	8.4	52.5	43.0
G	2000	2000	2000	2.4	7.5	25.5	22.3
H	4000	4000	4000	2.3	8.0	13.2	11.1
J	6000	6000	6000	2.0	6.8	6.6	6.1

Note

- 1 Please refer to the approved drawing for the final authentic value.
- 2 This self-locking force level is reached only when a short circuit is applied on the terminals of the motor. All the TiMOTION control boxes have this feature built-in.
- 3 The current & speed in table are tested with 24V DC motor. With a 12V DC motor, the current is approximately twice the current measured in 24V DC. With a 36V DC motor, the current is approximately two-thirds the current measured in 24V DC. Speed will be similar for all the voltages.
- 4 The current & speed in table are tested when the actuator is extending under push load.
- 5 The current & speed in table and diagram are tested with a stable 24V DC power supply.
- 6 Standard stroke: Min. ≥ 25 mm, Max. please refer to below table.

CODE	Load (N)	Max Stroke (mm)
H, J	≥ 4000	600
G	$= 2000$	800
F	< 1000	1000

Performance Data (24V DC Motor)

Motor Speed (5200RPM, Duty Cycle 25%)

Speed vs. Load

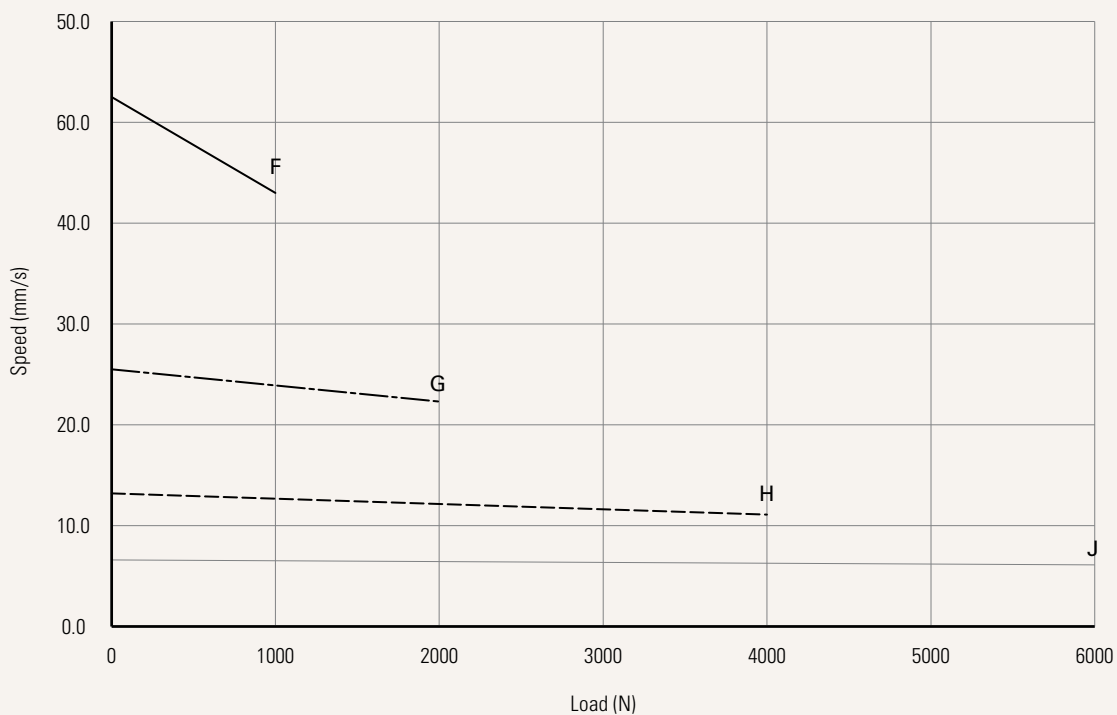

Current vs. Load

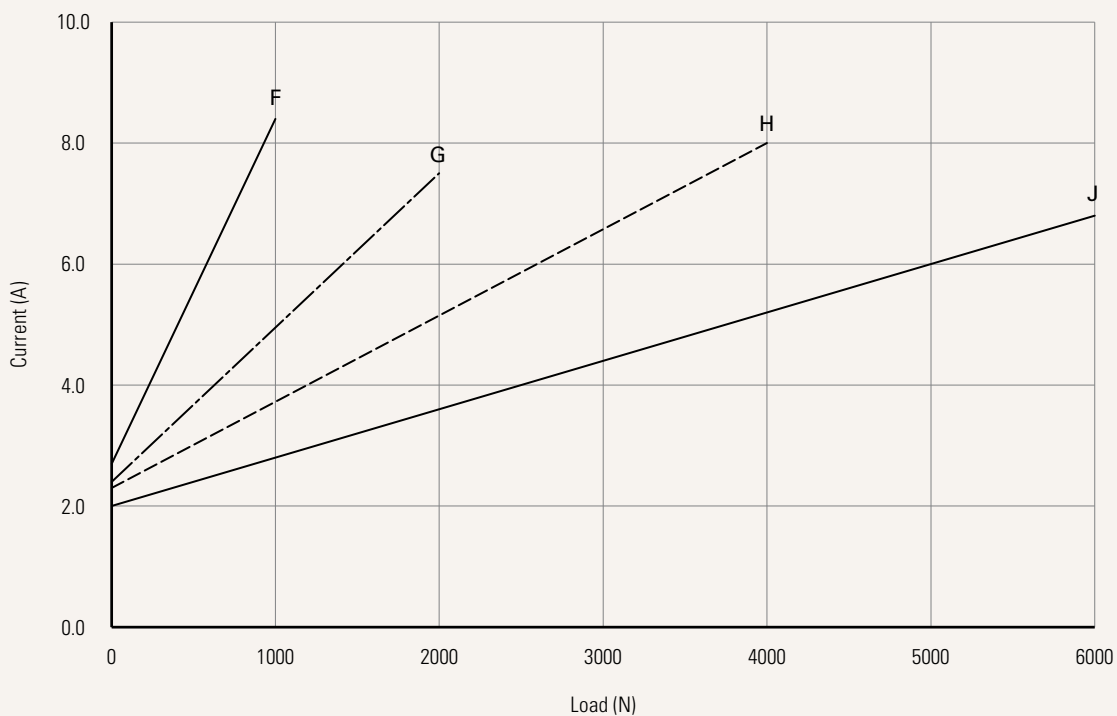

Voltage	1 = 12V DC 2 = 24V DC 3 = 36V DC	5 = 24VDC, thermal protector 6 = 12VDC, thermal protector 7 = 36VDC, thermal protector
Load and Speed	See page 2	
Stroke (mm)		
Retracted Length (mm)	See page 5	
Rear Attachment (mm) See page 6	1 = Aluminum casting, clevis U, slot 8.2, depth 12.5, hole 10.2 2 = Aluminum casting, clevis U, slot 8.2, depth 15.0, hole 10.2 3 = Aluminum casting, clevis U, slot 8.2, depth 15.0, hole 12.8 4 = Aluminum casting, clevis U, slot 8.2, depth 15.0, hole 12.2	
Front Attachment (mm) See page 6	1 = Iron inner tube with punched hole, without slot, hole 10.2 2 = Iron inner tube with punched hole, without slot, hole 12.2 3 = Iron inner tube with punched hole, without slot, hole 12.8 4 = Aluminum casting, clevis U, slot 8.2, depth 15.0, hole 10.2 5 = Aluminum casting, clevis U, slot 8.2, depth 15.0, hole 12.2 6 = Aluminum casting, clevis U, slot 8.2, depth 15.0, hole 12.8 K = Rod end bearing, hole 12.8	
Direction of Installation (Counterclockwise) See page 7	1 = 90°	2 = 0°
Functions for Limit Switches See page 7	1 = Two switches at full retracted / extended positions to cut current 2 = Two switches at full retracted / extended positions to cut current + third one in between to send signal 6 = Two switches at full retracted / extended positions to cut current + send signal	
Reed Sensor on the Outer Tube	0 = Without	1 = Reed sensor*1 2 = Reed sensor*2
Output Signal	0 = Without	1 = POT 5 = Hall sensor*2
Connector See page 7	2 = Tinned leads	
Cable Length (mm)	1 = Straight, 500	2 = Straight, 1000 3 = Straight, 1500 4 = Straight, 2000
IP Rating	1 = Without 2 = IP54	3 = IP66 6 = IP66D 8 = IP69K
Manual Drive	0 = Without	1 = With
T-Smart	0 = Without	

Retracted Length (mm)

1. Calculate $A+B+C = Y$
2. Retracted length needs to \geq Stroke + Y

A. Rear/ Front Attachment		
Front Attachment	Rear Attachment	
	1	2, 3, 4
1, 2, 3	+131	+134
4, 5, 6	+161	+164
K	+178	+181

C. Output Signal	
0, 5	-
1	+20

B. Stroke (mm)	
25~150	-
151~200	-
201~250	+10
251~300	+20
301~350	+30
351~400	+40
401~450	+50
451~500	+60
501~550	+70
551~600	+80
601~650	+90
651~700	+100
701~750	+110
751~800	+120
801~850	+130
851~900	+140
901~950	+155
951~1000	+160

Rear Attachment (mm)

1 = Aluminum casting, clevis U, slot 8.2, depth 12.5, hole 10.2

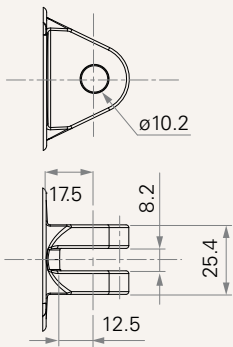

2 = Aluminum casting, clevis U, slot 8.2, depth 15.0, hole 10.2

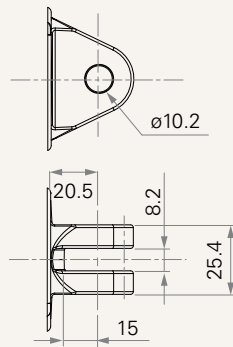

3 = Aluminum casting, clevis U, slot 8.2, depth 15.0, hole 12.8

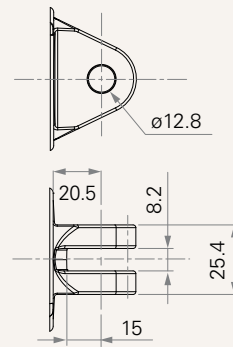

4 = Aluminum casting, clevis U, slot 8.2, depth 15.0, hole 12.2

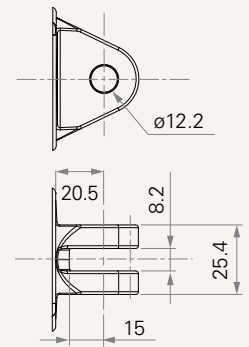

Front Attachment (mm)

1 = Iron inner tube with punched hole, without slot, hole 10.2

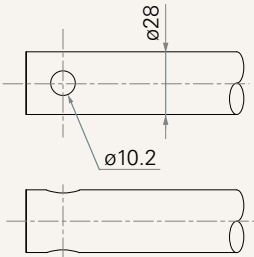

2 = Iron inner tube with punched hole, without slot, hole 12.2

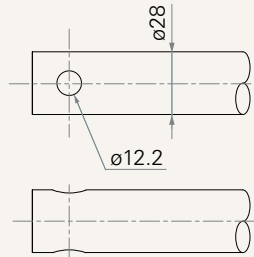

3 = Iron inner tube with punched hole, without slot, hole 12.8

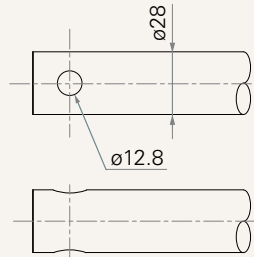

4 = Aluminum casting, clevis U, slot 8.2, depth 15.0, hole 10.2

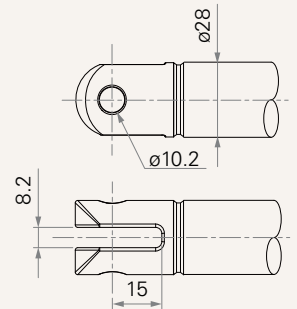

5 = Aluminum casting, clevis U, slot 8.2, depth 15.0, hole 12.2

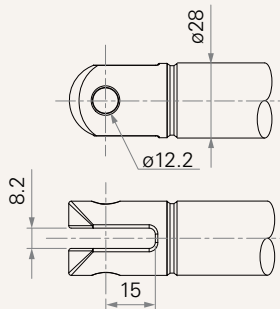

6 = Aluminum casting, clevis U, slot 8.2, depth 15.0, hole 12.8

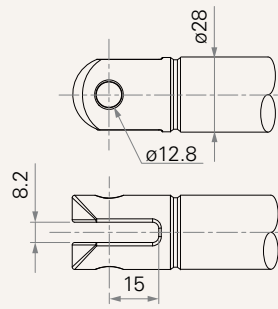

K = Rod end bearing, hole 12.8

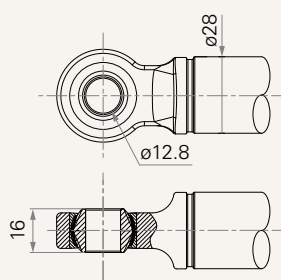

Direction of Rear Attachment (Counterclockwise)

1 = 90°

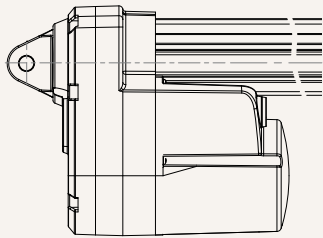

2 = 0°

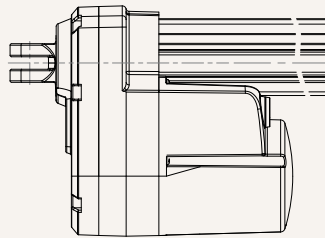

Functions for Limit Switches

Wire Definitions

CODE	● (Green)	● (Red)	○ (White)	● (Black)	● (Yellow)	● (Blue)
1	extend (VDC+)	N/A	N/A	N/A	retract (VDC+)	N/A
2	extend (VDC+)	N/A	middle switch pin B	middle switch pin A	retract (VDC+)	N/A
6	extend (VDC+)	N/A	upper limit switch	lower limit switch	retract (VDC+)	N/A

Connector

2 = Tinned leads

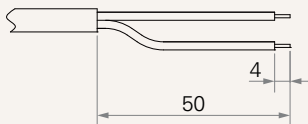

Terms of Use

The user is responsible for determining the suitability of TiMOTION products for a specific application. TiMOTION products are subject to change without prior notice.