

JP3

series



Product Segments

- **Industrial Motion**

TiMOTION's JP3 series inline linear actuator was designed for low load industrial applications where up to IP69K dust and liquid ingress protection is necessary. It is best suited for applications with visual or compact installation dimension requirements. Hall sensors are optional for the JP3 which allow for synchronization and position feedback.

General Features

Voltage of motor	12V DC, 24V DC, or 24V DC (PTC)
Maximum load	2,000N in push / pull
Maximum speed at full load	19mm/s (with 500N in a push or pull condition)
Stroke	20~1000mm
Minimum installation dimension	≥ Stroke + 217mm
IP rating	Up to IP69K
Color	Black or grey
Certificate	UL73
Operational temperature range	-5°C~+65°C
Operational temperature range at full performance	+5°C~+45°C
Storage temperature range	-40°C~+70°C

An inline actuator designed for small spaces

Drawing

Standard Dimensions
(mm)

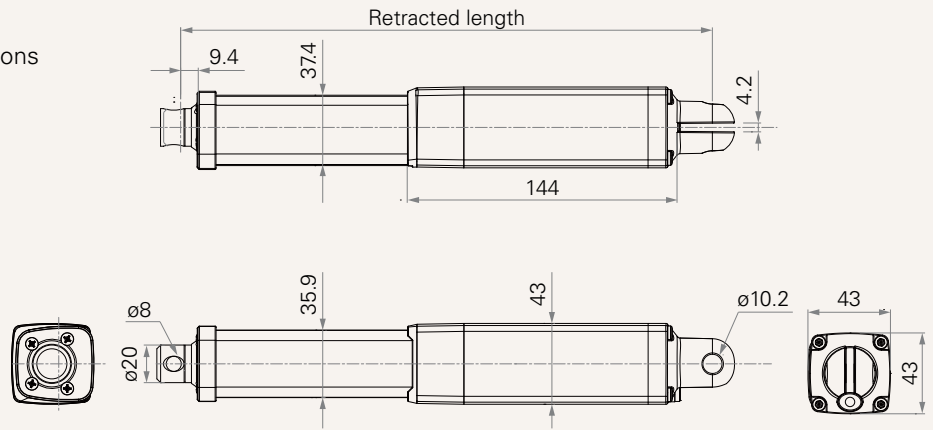

Load and Speed

CODE	Load (N)		Self Locking Force (N)	Typical Current (A)		Typical Speed (mm/s)	
	Push	Pull		No Load 32V DC	With Load 24V DC	No Load 32V DC	With Load 24V DC
Motor Speed (5600RPM, Duty Cycle 10%)							
B	2000	2000	2000	1.0	3.0	7.0	3.5
C	1500	1500	1500	1.0	3.0	10.0	6.5
D	1000	1000	1000	1.0	3.0	14.5	8.5
E	500	500	500	1.0	3.0	23.5	19.0

Note

- 1 Please refer to the approved drawing for the final authentic value.
- 2 Standard stroke: Min. ≥ 20 mm, Max. please refer to below table
- 3 This self-locking force level is reached only when a short circuit is applied on the terminals of the motor. All the TiMOTION control boxes have this feature built-in.
- 4 The current & speed in table are tested with 24V DC motor. With a 12V DC motor, the current is approximately twice the current measured in 24V DC; speed will be similar for both voltages.
- 5 The current & speed in table are tested when the actuator is extending under push load.
- 6 The current & speed in table and diagram are tested with a stable 24V DC power supply.

CODE	Load (N)	Max Stroke (mm)
B	2000	500
C	1500	600
D	1000	800
E	500	1000

Performance Data (24V DC Motor)

Motor Speed (5600RPM, Duty Cycle 10%)

Speed vs. Load

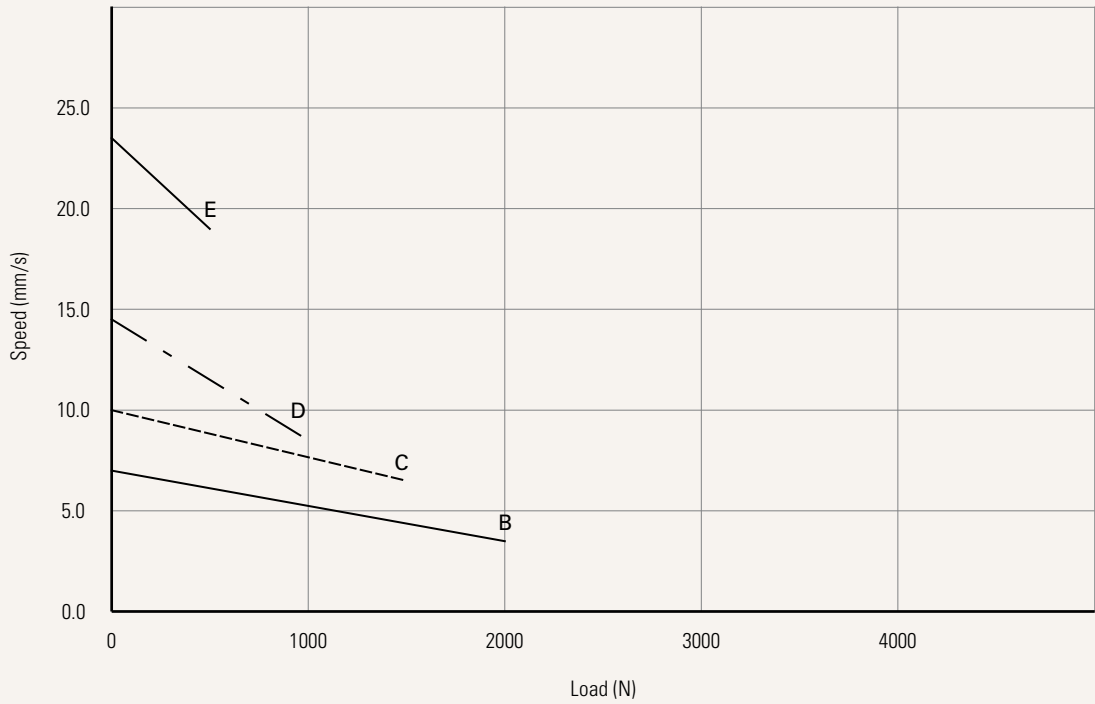

Current vs. Load

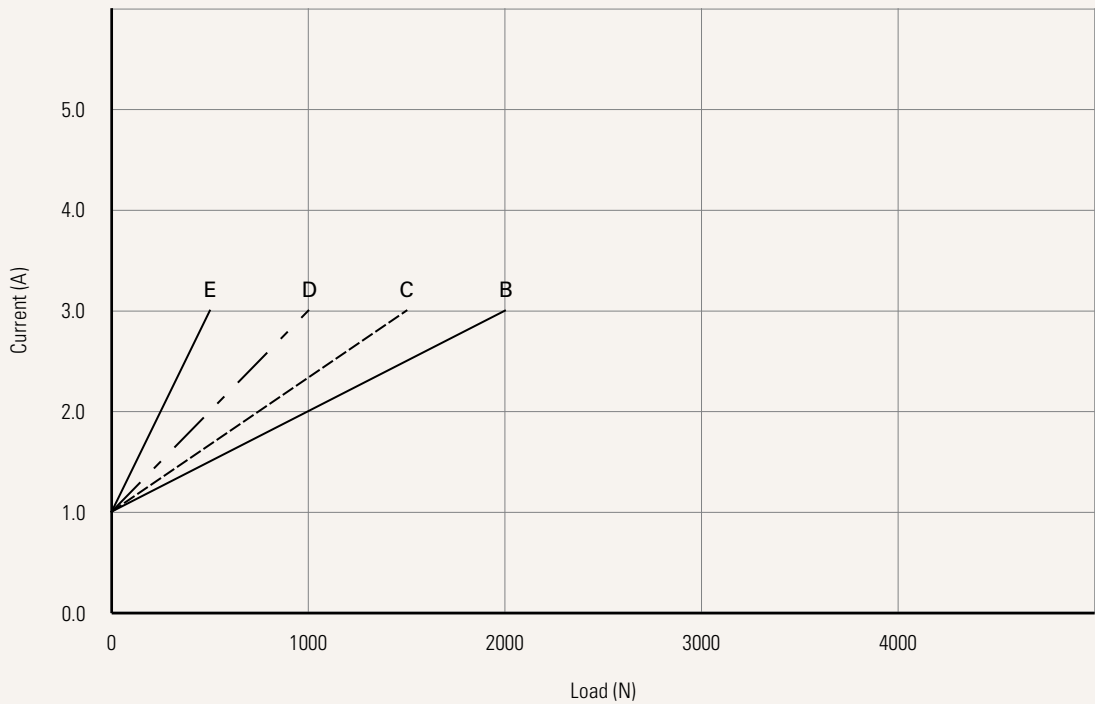

Note

1 The performance data in the curve charts shows theoretical value.

Voltage	1 = 12V DC	2 = 24V DC	5 = 24V DC, PTC	6 = 12V DC, PTC
Load and Speed	See page 2			
Stroke (mm)				
Retracted Length (mm)	See page 2			
Rear Attachment (mm)	1 = Aluminum casting, U clevis, slot 4.2, depth 18.0, hole 10.2			
	See page 6			
Front Attachment (mm)	1 = Aluminum casting, no slot, hole 6.4			
	2 = Aluminum casting, no slot, hole 8.0			
	3 = Aluminum CNC, U clevis, slot 6.0, depth 13.0, hole 10.0			
	4 = Aluminum CNC, U clevis, slot 6.0, depth 13.0, hole 6.4			
	5 = Aluminum CNC, U clevis, slot 6.0, depth 13.0, hole 8.0			
	6 = Aluminum casting, hole 10.0			
Direction of Rear Attachment (Counterclockwise)	1 = 0°			
	See page 6			
Color	1 = Black	2 = Grey (Pantone 428C)		
IP Rating	1 = Without	3 = IP66	6 = IP66D	8 = IP69K
	2 = IP54	5 = IP66W	7 = IP68	
Special Functions for Spindle Sub-Assembly	0 = Without (Standard)			
Functions for Limit Switches	1 = Two switches at full retracted / extended positions to cut current			
	2 = Two switches at full retracted / extended positions to cut current + 3rd LS to send signal			
	3 = Two switches at full retracted / extended positions to send signal			
	4 = Two switches at full retracted / extended positions to send signal + 3rd LS to send signal			
	See page 7			
Output Signal	0 = Without	2 = Hall sensor * 2		
Connector	1 = DIN 6P, 90° plug	2 = Tinned leads		
	See page 7			
Cable Length (mm)	0 = Straight, 100	1 = Straight, 500	3 = Straight, 1000	

Retracted Length (mm)

1. Calculate $A+B+C = Y$
2. Retracted length needs to \geq Stroke + Y

A. Front Attachment

1, 2, 6	+217
3, 4, 5	+230

B. Stroke (mm)

20~150	-
151~200	-
201~250	+5
251~300	+10
301~350	+15
351~400	+20
401~450	+25
451~500	+30
501~550	+35
551~600	+40
601~650	+45
651~700	+50
701~750	+55
751~800	+60
801~850	+65
851~900	+70
901~950	+75
951~1000	+80

C. Output Signal

0	-
2	+13

Rear Attachment (mm)

1 = Aluminum casting, U clevis, slot 4.2, depth 18.0, hole 10.2

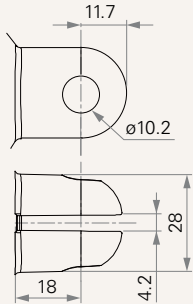

Front Attachment (mm)

1 = Aluminum casting, no slot, hole 6.4

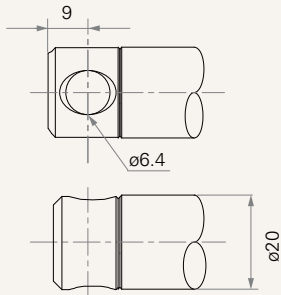

2 = Aluminum casting, no slot, hole 8.0

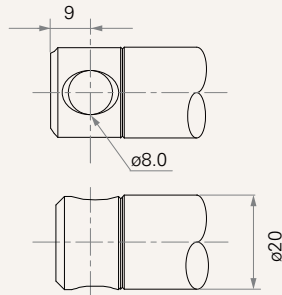

3 = Aluminum CNC, U clevis, slot 6.0, depth 13.0, hole 10.0

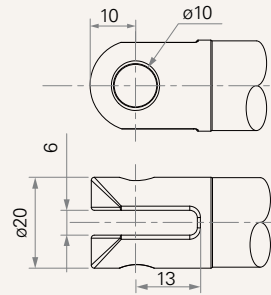

4 = Aluminum CNC, U clevis, slot 6.0, depth 13.0, hole 6.4

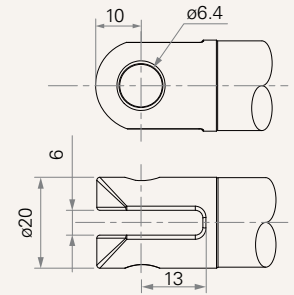

5 = Aluminum CNC, U clevis, slot 6.0, depth 13.0, hole 8.0

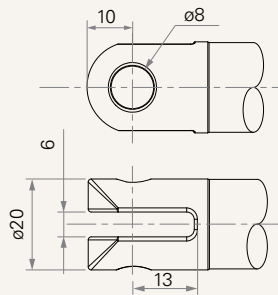

6 = Aluminum casting, hole 10.0

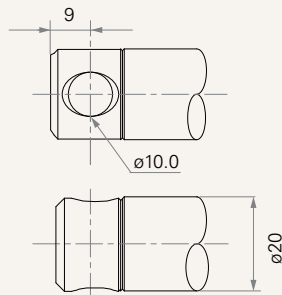

Direction of Rear Attachment (Counterclockwise)

1 = 0°

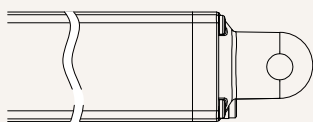

Functions for Limit Switches

Wire Definitions

CODE	Pin					
	● 1 (Green)	● 2 (Red)	○ 3 (White)	● 4 (Black)	● 5 (Yellow)	● 6 (Blue)
1	extend (VDC+)	N/A	N/A	N/A	retract (VDC+)	N/A
2	extend (VDC+)	N/A	middle switch pin B	middle switch pin A	retract (VDC+)	N/A
3	extend (VDC+)	common	upper limit switch	N/A	retract (VDC+)	lower limit switch
4	extend (VDC+)	common	upper limit switch	medium limit switch	retract (VDC+)	lower limit switch

Connector

1 = DIN 6P, 90° plug

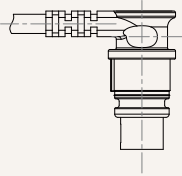

2 = Tinned leads

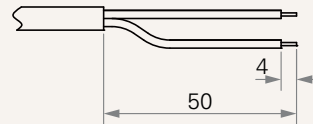

Terms of Use

The user is responsible for determining the suitability of TiMOTION products for a specific application. TiMOTION products are subject to change without prior notice.