

ACTUATION SYSTEMS for NURSING HOME PATIENT LIFT APPLICATIONS

TiMOTION provides a simpler actuation solution for patient lifts. We offer an alternative for medical environments that require safe and easy-to-use patient transfer.

This solution ensures safety and comfortability in patient lifts at nursing homes.

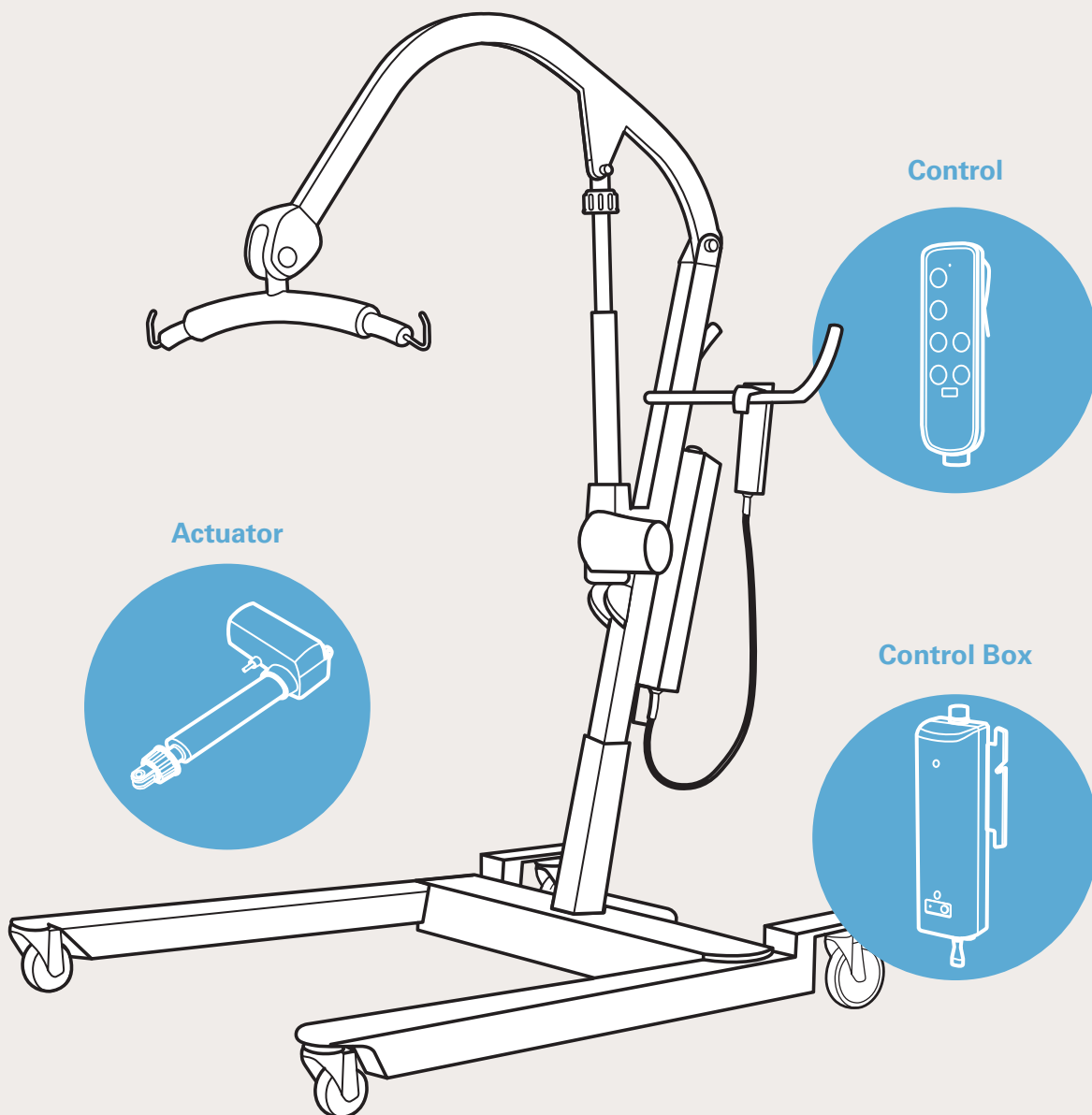

A SMART AND EASY TO USE ACTUATOR SYSTEM FOR PATIENT LIFTS

TC20 is a simpler control box for a patient hoist system which meets specific patient needs and secures a safe and comfortable transfer. It is portable and easily installable within nursing home applications.

TC20 KEY FEATURES:

- Built-in battery pack: 24V, 2.9Ah or 5Ah
- Charging with AC cable or plug directly
- IP rating: Up to IP66
- Cable management bracket (optional)
- Emergency stop button
- Easy installation, only two screws required
- LED power indicator on the battery pack (optional)

System Overview

Control box: TC20

Control: TH10, TMH3 or TMH13

Actuators for lifting: TA23, TA36 or TA37

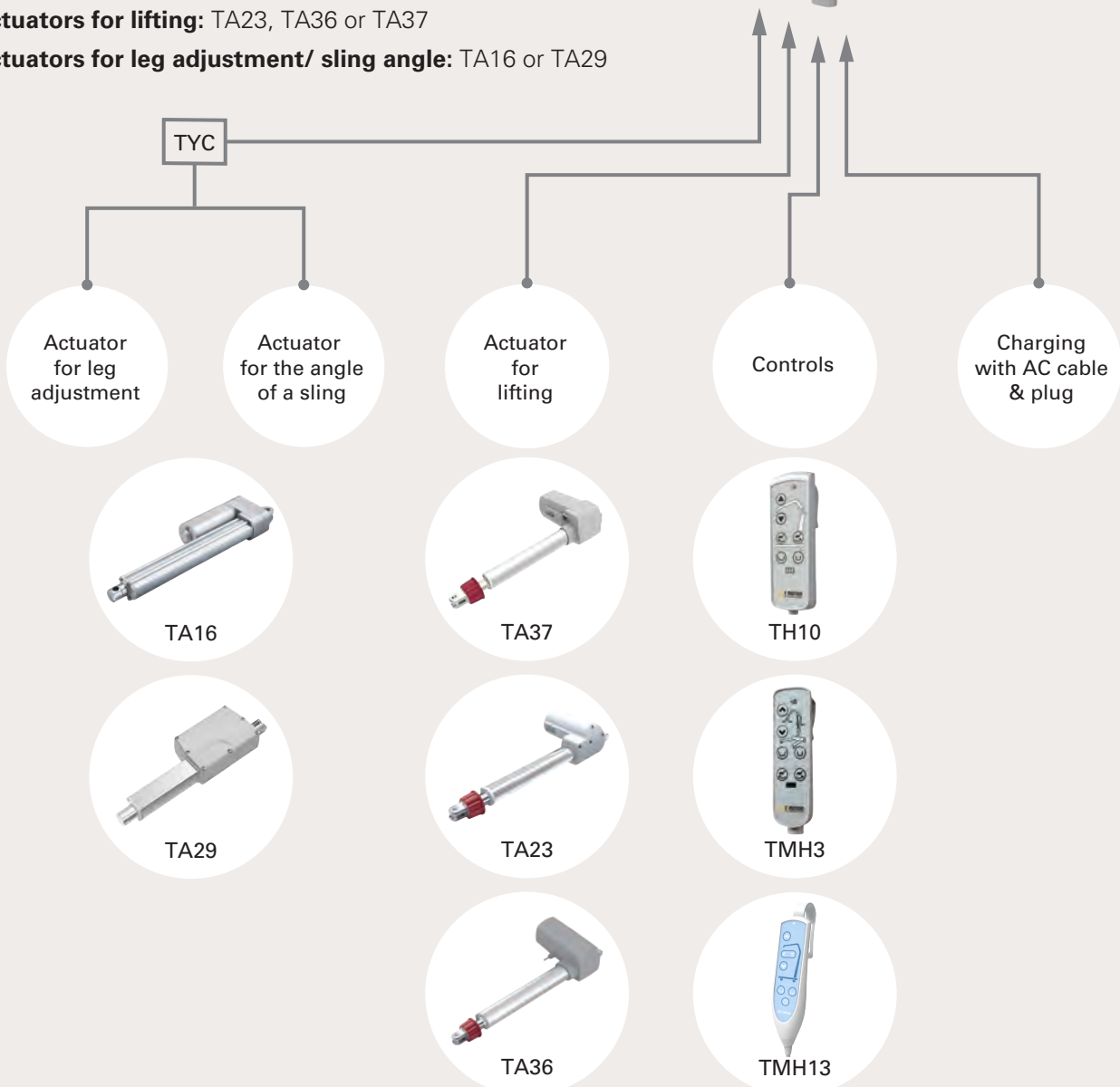

Actuators for leg adjustment/ sling angle: TA16 or TA29



Actuator for Lifting

Model	Maximum Load in Push	Maximum Speed at Full Load	IP Rating	Manual Release
 TA36	10,000N	5.4mm/s	IP66W	Available
 TA23	10,000N	3.2mm/s	IP66W	
 TA37	12,000N	5.3mm/s	IP66W	

Actuator for Leg Adjustment / Angle of Sling

Model	Maximum Load in Push	Retracted Length
 TA29	6,000N	> 178mm
 TA16	3,500N	≥ Stroke+112mm



TMH13



TMH3



TH10

CONTROL TMH13, TMH3 or TH10 SERIES

- TMH3 has a detachable handset cord
- Supports a maximum of three actuators
- LED indicator for the battery status
- Interface for lifting/ lowering, leg adjustments, and overload warning

Installation Guide

1. Install TC20 on the hoist frame

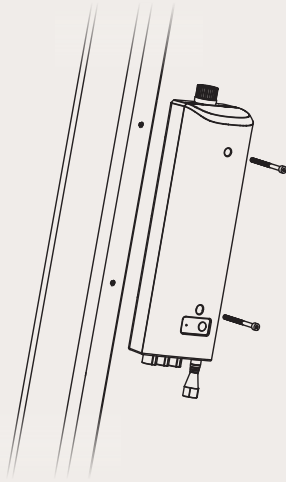

2. Install fixed screws of TC20. Make sure the screws are tightened properly

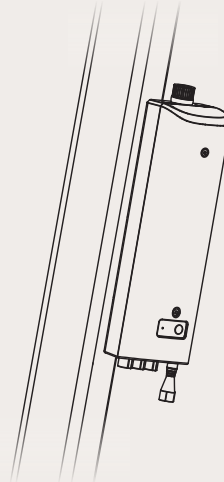

Standard Dimensions (mm)

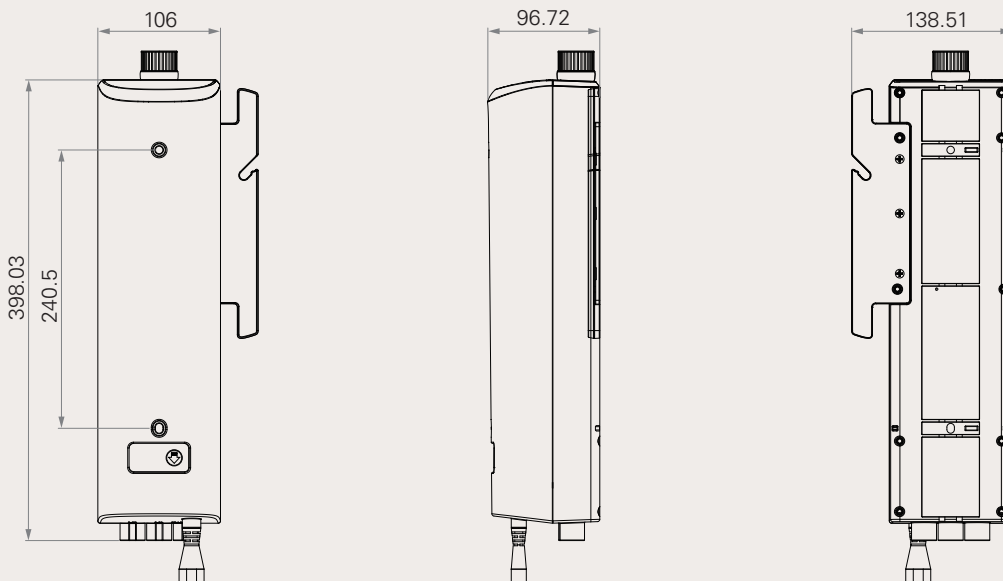

Taiwan & China

Tel +886 2 2219 6633
sales.tw@timotion.com

Japan

Tel +81 6 6713 1188
sales.jp@timotion.com

Korea

Tel +82 31 745 1060
sales@timotion.co.kr

Australia

Tel +61 3 8725 0331
sales.tw@timotion.com

Europe

Tel +33 (0)1 74 82 50 51
sales.eu@timotion.com

USA

Toll Free (855) 235 1424
sales.us@timotion.com

Latin America

Tel +55 11 5081 5011
sales.la@timotion.com

Russia

Tel +7 (921) 406-23-34
sales.cis@timotion.com