

TA6

series



Product Segments

- **Comfort Motion**

TiMOTION's TA6 series linear actuator is designed for lift applications like recliners, lifting chairs and movie theater seating. Its right angle design reduces noise and allows for fitment into most applications. Industry certifications for the TA6 linear actuator include EMC and RoHS. In addition, the TA6 is available with optional Hall sensors for position feedback. It can also be used where freewheeling push only functionality is desired.

General Features

Max. load	6,000N (push); 4,000N (pull)
Max. speed at max. load	5mm/s
Max. speed at no load	39mm/s
Retracted length	≥ Stroke + 163mm
Certificate	UL962, EMC
Stroke	25~1000mm
Options	Freewheeling push only, safety nut, Hall sensors
Voltage	12/24/36V DC
Color	Black
Operational temperature range	+5°C~+45°C

Drawing

Standard Dimensions
(mm)

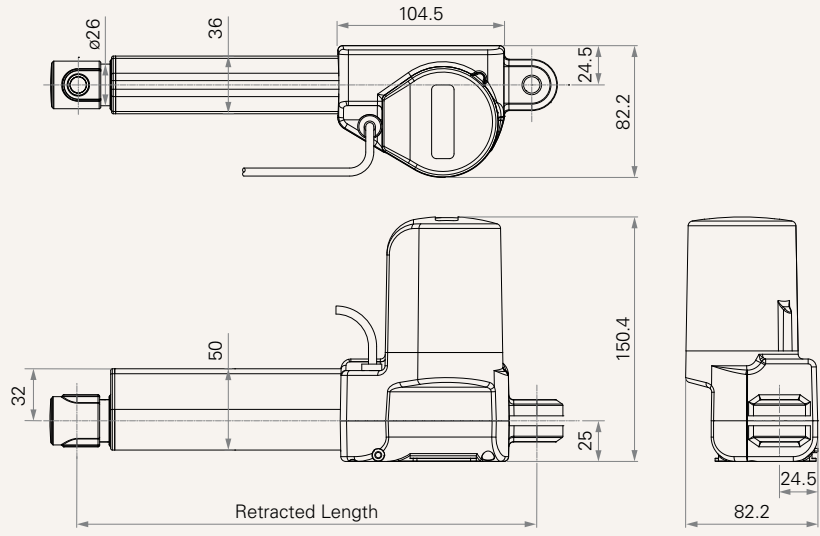

Load and Speed

CODE	Load (N)		Self Locking Force (N)	Typical Current (A)		Typical Speed (mm/s)	
	Push	Pull		No Load 32V DC	With Load 24V DC	No Load 32V DC	With Load 24V DC
Motor Speed (2600RPM, Duty Cycle 10%)							
C	5000	4000	5000	0.8	3.5	8.0	4.1
D	6000	4000	6000	0.8	3.5	6.0	3.1
F	2500	2500	2500	0.8	3.2	15.9	8.3
G	2000	2000	2000	0.8	2.8	21.4	12.1
H	1000	1000	1000	0.8	2.1	32.1	19.1
J	3500	3500	3500	0.8	3.6	11.9	6.0
Motor Speed (3400RPM, Duty Cycle 10%)							
L	6000	4000	6000	1.0	4.2	7.3	4.1
N	2500	2500	2500	1.0	4.1	19.4	11.1
O	2000	2000	2000	1.0	4.0	26.1	14.9
P	1000	1000	1000	1.0	3.0	39.0	23.4
Q	3500	3500	3500	1.0	4.6	14.5	7.9
T	5000	4000	5000	1.0	4.2	9.8	5.4
Motor Speed (3800RPM, Duty Cycle 10%)							
X	6000	4000	6000	1.2	4.4	8.6	5.0
U	5000	4000	5000	1.2	4.7	11.3	6.6
W	2500	2500	2500	1.2	4.6	23.0	13.4
Z	3500	3500	3500	1.2	5.3	16.8	9.8

Note

- 1 Please refer to the approved drawing for the final authentic value.
- 2 This self-locking force level is reached only when a short circuit is applied on the terminals of the motor. All the TiMOTION control boxes have this feature built-in.
- 3 Operational temperature range at full performance: +5°C~+45°C
- 4 The current & speed in table are tested with 24V DC motor. With a 12V DC motor, the current is approximately twice the current measured in 24V DC. With a 36V DC motor, the current is approximately two-thirds the current measured in 24V DC. Speed will be similar for all the voltages.
- 5 The current & speed in table are tested when the actuator is extending under push load.
- 6 The current & speed in table and diagram are tested with TiMOTION control boxes, and there will be around 10% tolerance depending on different models of the control box. (Under no load condition, the voltage is around 32V DC. At rated load, the voltage output will be around 24V DC)
- 7 Standard stroke: Min. ≥ 25mm, Max. please refer to below table.

CODE	Load (N)	Max Stroke (mm)
D, L, X	= 6000	600
Others	< 6000	1000

Performance Data (24V DC Motor)

Motor Speed (2600RPM, Duty Cycle 10%)

Speed vs. Load

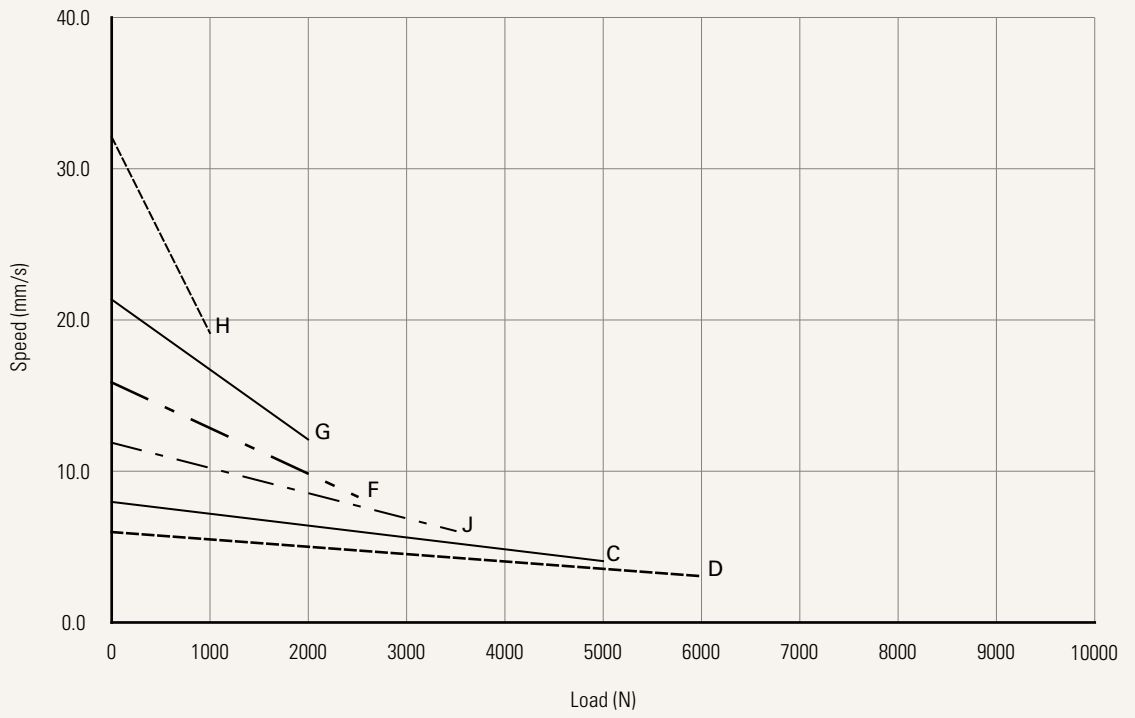

Current vs. Load

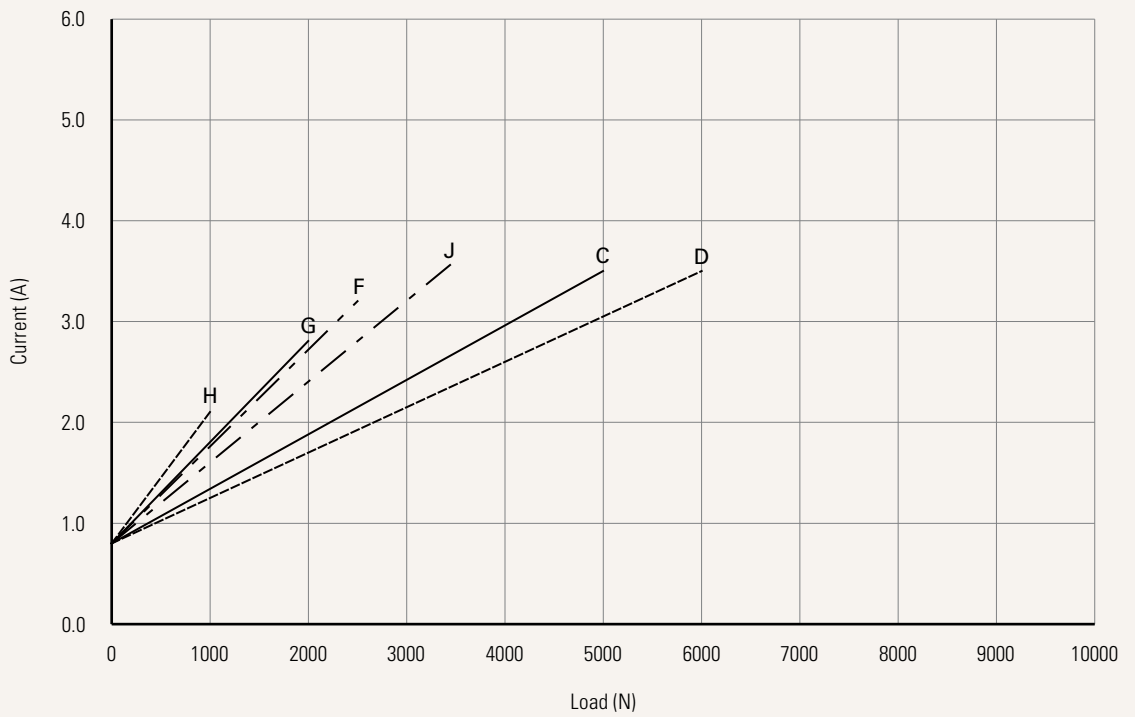

Performance Data (24V DC Motor)

Motor Speed (3400RPM, Duty Cycle 10%)

Speed vs. Load

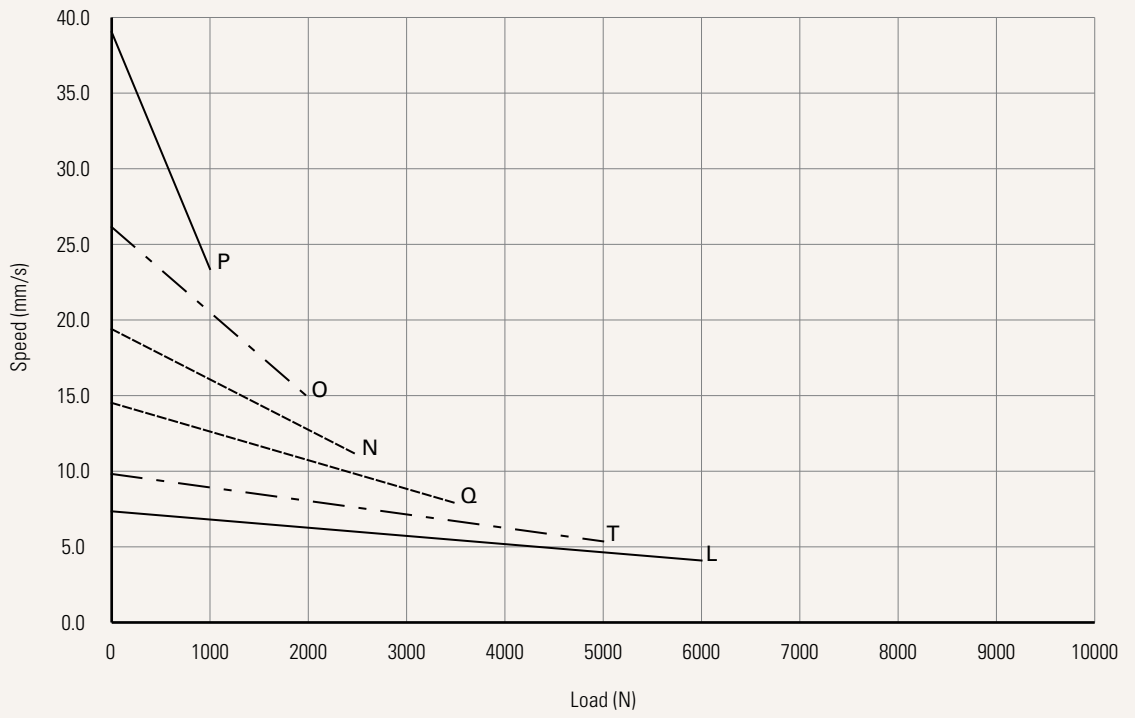

Current vs. Load

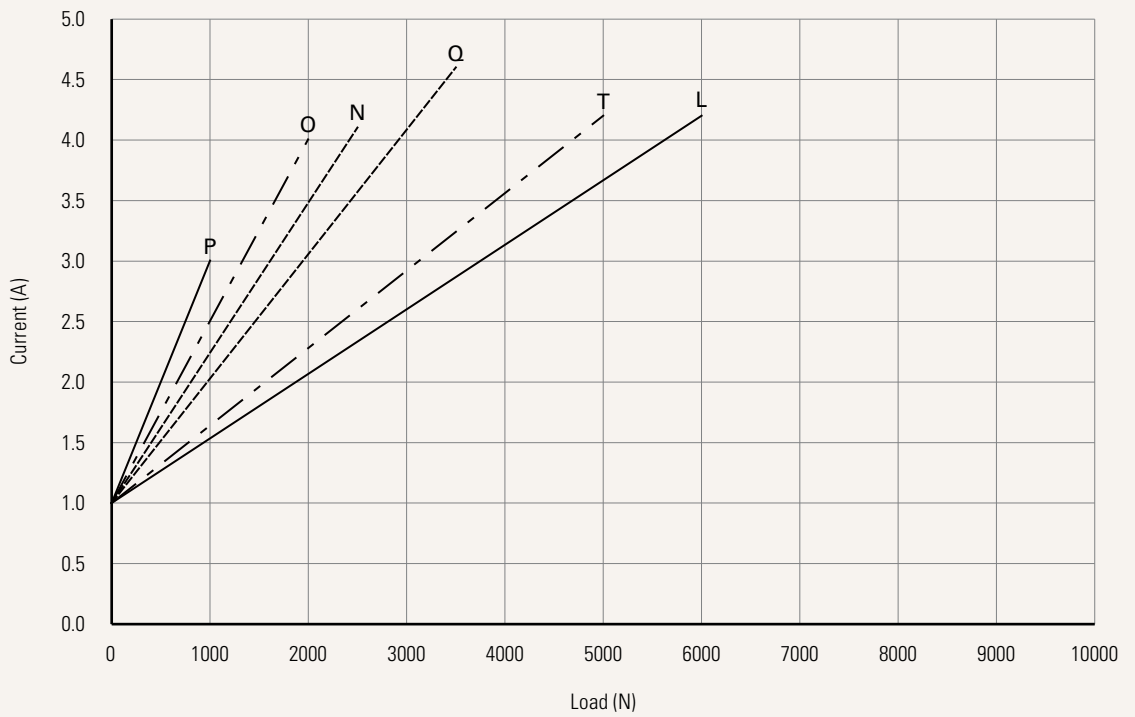

Performance Data (24V DC Motor)

Motor Speed (3800RPM, Duty Cycle 10%)

Speed vs. Load

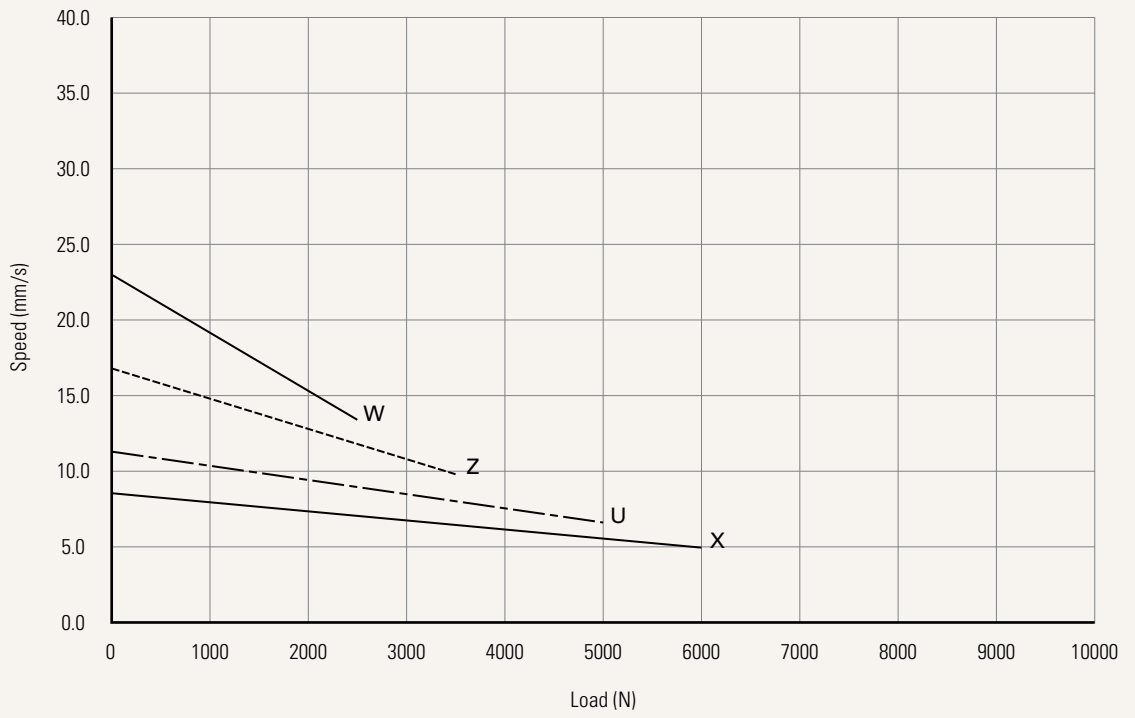

Current vs. Load

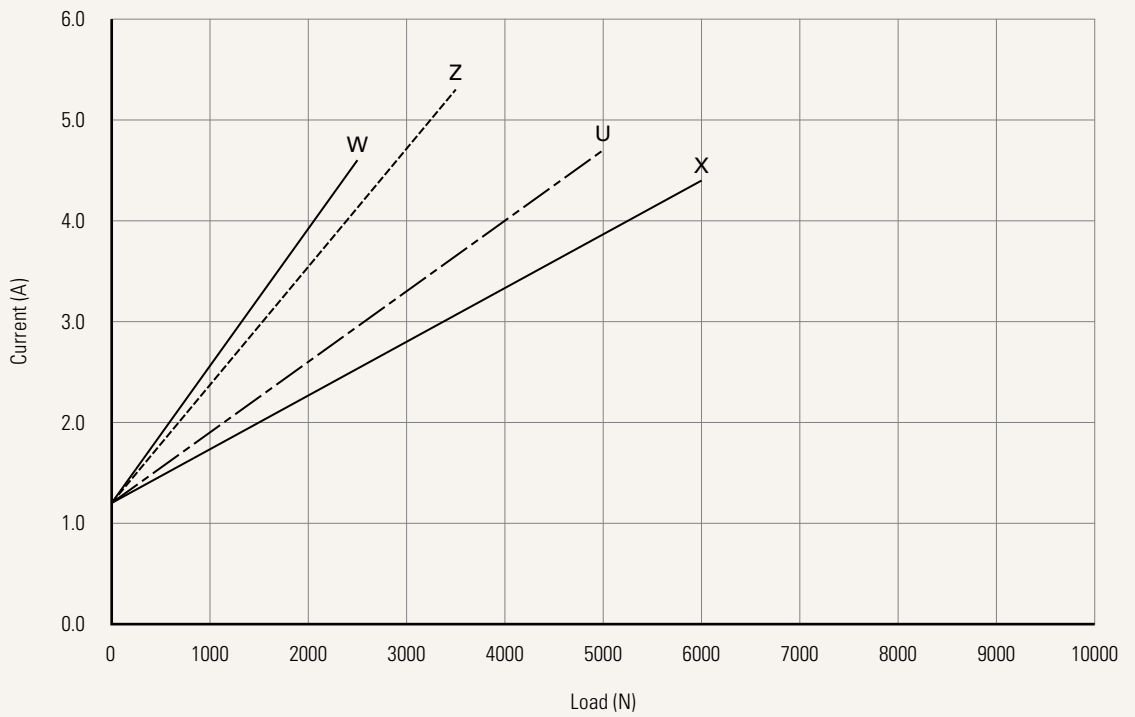

Voltage	1 = 12V DC	2 = 24V DC	3 = 36V DC
Load and Speed	See page 3		
Stroke (mm)	See page 3		
Retracted Length (mm)	See page 8		
Rear Attachment (mm)	1 = Plastic, U clevis, slot 6.1, hole 10.2		
	See page 9		
Front Attachment (mm)	1 = Punched hole on inner tube + plastic cap, without slot, hole 10.2, with plastic bushing	6 = Punched hole on inner tube, without slot, hole 12.2	
	2 = Punched hole on inner tube + plastic cap, without slot, hole 12.2	7 = Aluminum casting, U clevis, slot 6.2, depth 17.0, hole 10.2	
	3 = Plastic, U clevis, slot 8.2, depth 20.2, hole 10.2, for load push < 4000N & pull < 2500N	8 = Aluminum casting, U clevis, slot 6.2, depth 17.0, hole 12.2	
	4 = Plastic, U clevis, slot 8.2, depth 20.2, hole 12.2, for load push < 4000N & pull < 2500N	9 = Aluminum casting, U clevis, slot 6.2, depth 17.0, hole 10.2, with plastic T-bushing	
	5 = Punched hole on inner tube, without slot, hole 10.2, with plastic bushing		
Color	1 = Black		
Special Functions for Spindle Sub-Assembly	0 = Without	2 = Standard push only	
	1 = Safety nut	3 = Standard push only + safety nut	
Functions for Limit Switches	1 = Two switches at full retracted / extended positions to cut current		
	2 = Two switches at full retracted / extended positions to cut current + third one in between to send signal		
	3 = Two switches at full retracted / extended positions to send signal		
	4 = Two switches at full retracted / extended positions to send signal + third one in between to send signal		
Output Signals	0 = Without	2 = Hall sensor*2	
Connector	1 = DIN 6P, 90° plug	B = Y cable (For direct cut system, non water proof, non anti pull)	
	2 = Tinned leads	P = Molex 8P, 90° plug, without anti-clip	
	3 = Small 01P, plug		
Cable Length (mm)	0 = Straight, 100	3 = Straight, 1000	6 = Straight, 2000
	1 = Straight, 500	4 = Straight, 1250	7 = Curly, 200
	2 = Straight, 750	5 = Straight, 1500	8 = Curly, 400
			B-H = For direct cut system
			See page 10

Retracted Length (mm)

1. Calculate $A+B+C = Y$
2. Retracted length needs to \geq Stroke + Y

A. Front Attachment

CODE

1, 2, 5, 6	+163
3, 4	+185
7, 8, 9	+175

B. Load V.S. Stroke

Stroke (mm)	Load (N)	
	< 6000	= 6000
25~150	-	-
151~200	-	-
201~250	-	+5
251~300	-	+10
301~350	+5	+15
351~400	+10	+20
401~450	+15	+25
451~500	+20	+30
501~550	+25	+35
551~600	+30	+40
601~650	+35	x
651~700	+40	x
701~750	+45	x
751~800	+50	x
801~850	+55	x
851~900	+60	x
901~950	+65	x
951~1000	+70	x

C. Front Attachment V.S Special Function

Front Attachment	Spindle Function	
	0, 1	2, 3
1, 2, 5, 6	-	+5
3, 4	-	-
7, 8, 9	-	-

Rear Attachment (mm)

1 = U clevis plastic, slot 6.1, hole 10.2

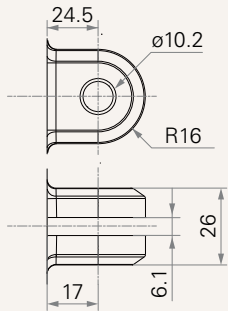

Front Attachment (mm)

1 = Punched hole on inner tube + plastic cap, without slot, hole 10.2, with plastic bushing

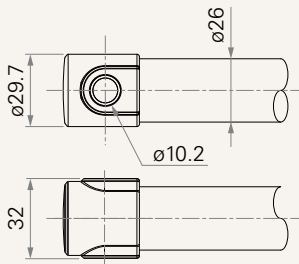

2 = Punched hole on inner tube + plastic cap, without slot, hole 12.2

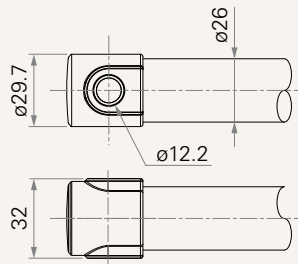

3 = Plastic, U clevis, slot 8.2, depth 20.2, hole 10.2, for load push < 4000N & pull < 2500N

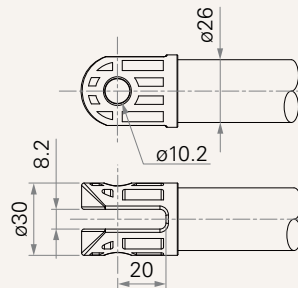

4 = Plastic, U clevis, slot 8.2, depth 20.2, hole 12.2, for load push < 4000N & pull < 2500N

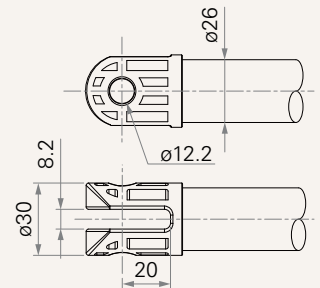

5 = Punched hole on inner tube, without slot, hole 10.2, with plastic bushing

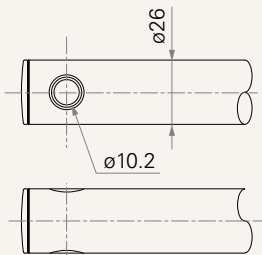

6 = Punched hole on inner tube, without slot, hole 12.2

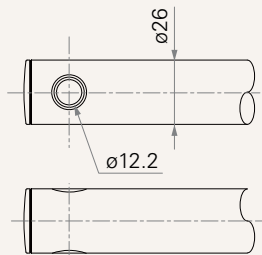

7 = Aluminum casting, U clevis, slot 6.2, depth 17.0, hole 10.2

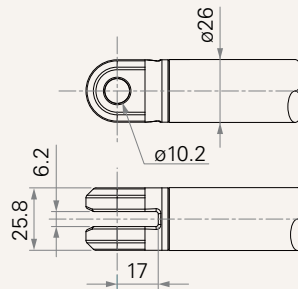

8 = Aluminum casting, U clevis, slot 6.2, depth 17.0, hole 12.2

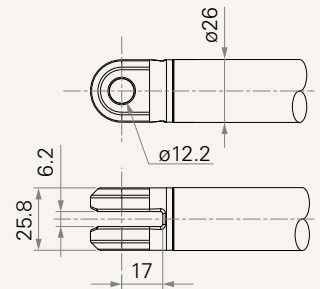

9 = Aluminum casting, U clevis, slot 6.2, depth 17.0, hole 10.2, with plastic T-bushing

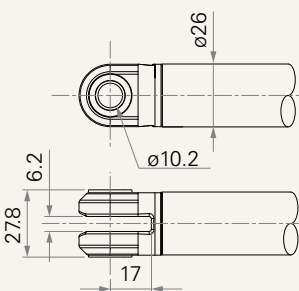

Functions for Limit Switches

Wire Definitions

CODE	Pin					
	● 1 (Green)	● 2 (Red)	○ 3 (White)	● 4 (Black)	● 5 (Yellow)	● 6 (Blue)
1	extend (VDC+)	N/A	N/A	N/A	retract (VDC+)	N/A
2	extend (VDC+)	N/A	middle switch pin B	middle switch pin A	retract (VDC+)	N/A
3	extend (VDC+)	common	upper limit switch	N/A	retract (VDC+)	lower limit switch
4	extend (VDC+)	common	upper limit switch	medium limit switch	retract (VDC+)	lower limit switch

Connector

1 = DIN 6P, 90° plug

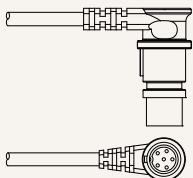

2 = Tinned leads

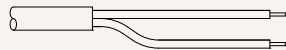

3 = Small 01P, plug

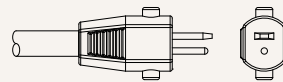

B = Y cable (For direct cut system, non water proof, non anti pull)

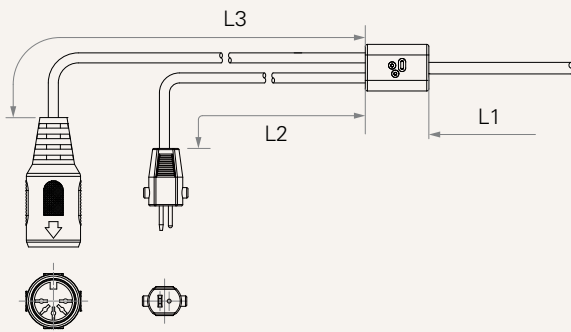

Cable length for direct cut system (mm)

CODE	L1	L2	L3
B	100	100	100
C	100	1000	400
D	100	2700	500
E	1000	100	100
F	100	600	1000
G	1500	1000	1000
H	100	100	1200

P = Molex 8P, 90° plug, without anti-clip

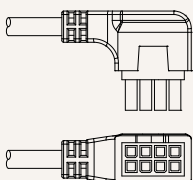

Terms of Use

The user is responsible for determining the suitability of TiMOTION products for a specific application. TiMOTION products are subject to change without prior notice.