

TA10

series



Product Segments

- **Care Motion**

TiMOTION's TA10 series linear actuator is primarily used in the medical market. This actuator series handles high loads and is designed with a manual crank attachment. If necessary, medical staff will be able to easily operate the manual crank to adjust the patient bed. In addition, this linear actuator is available with an optional IP54 or 66 rating.

General Features

Max. load	6,000N (push), 4,000N (pull)
Max. speed at max. load	4.2mm/s
Max. speed at no load	14.5mm/s
Retracted length	≥ Stroke + 188mm
IP rating	IP66
Certificate	IEC60601-1, ES60601-1
Stroke	25~300mm
Options	Hall sensor (s)
Voltage	12V DC, 24V DC, 36V DC or 24V DC (PTC)
Color	Black or grey
Operational temperature range	+5°C~+45°C
With manual crank function	

Drawing

Standard Dimensions
(mm)

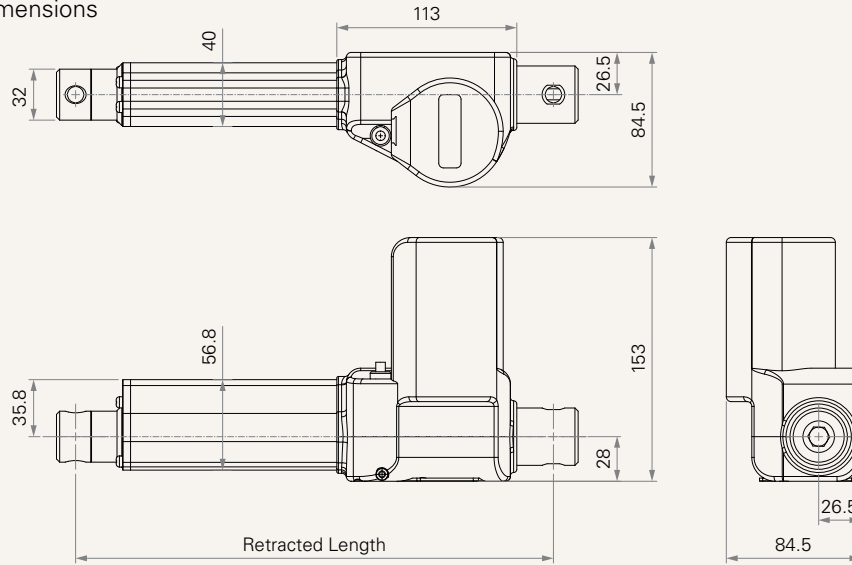

Load and Speed

CODE	Load (N)		Self Locking Force (N)	Typical Current (A)		Typical Speed (mm/s)	
	Push	Pull		No Load 32V DC	With Load 24V DC	No Load 32V DC	With Load 24V DC
Motor Speed (2600RPM, Duty Cycle 10%)							
D	6000	4000	2500	≤ 0.6	3.6	5.95	3.3
J	3500	3500	1500	≤ 0.6	3.7	11.5	5.8
Motor Speed (3400RPM, Duty Cycle 10%)							
L	6000	4000	2500	≤ 0.7	4.2	7.3	4.2
Q	3500	3500	1500	≤ 0.7	4.8	14.5	7.7

Note

- 1 Please refer to the approved drawing for the final authentic value.
- 2 This self-locking force level is reached only when a short circuit is applied on the terminals of the motor. All the TiMOTION control boxes have this feature built-in.
- 3 The current & speed in table are tested when the actuator is extending under push load.
- 4 The current & speed in table and diagram are tested with TiMOTION control boxes, and there will be around 10% tolerance depending on different models of the control box. (Under no load condition, the voltage is around 32V DC. At rated load, the voltage output will be around 24V DC)
- 5 The current & speed in table and diagram are tested with a stable 24V DC power supply.
- 6 Standard stroke: Min. ≥ 25mm, Max. please refer to below table.

CODE	Load (N)	Max Stroke (mm)
J, Q	= 3500	300
D, L	= 6000	200

Performance Data (24V DC Motor)

Motor Speed (2600RPM)

Speed vs. Load

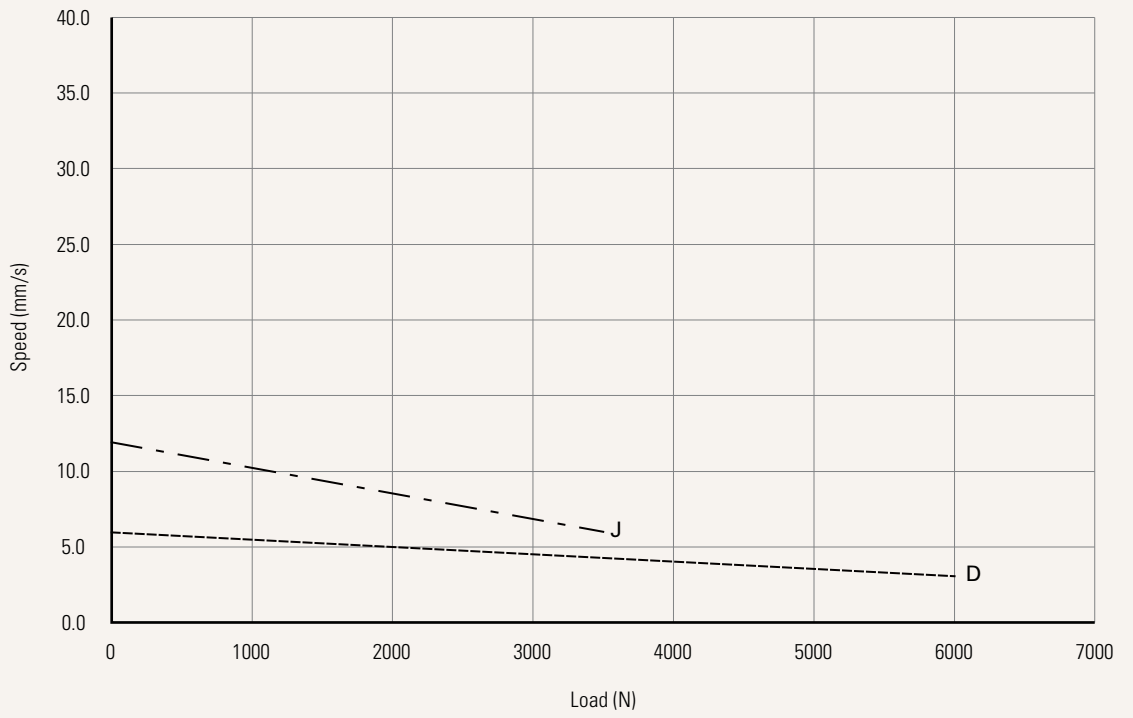

Current vs. Load

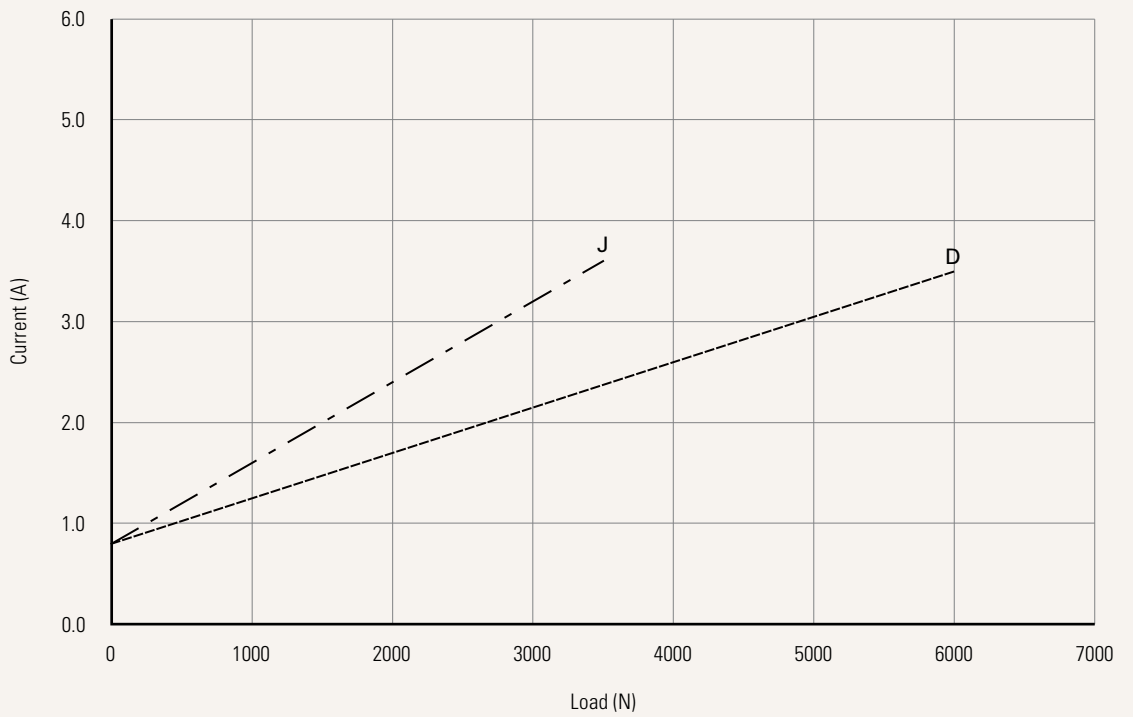

Performance Data (24V DC Motor)

Motor Speed (3400RPM)

Speed vs. Load

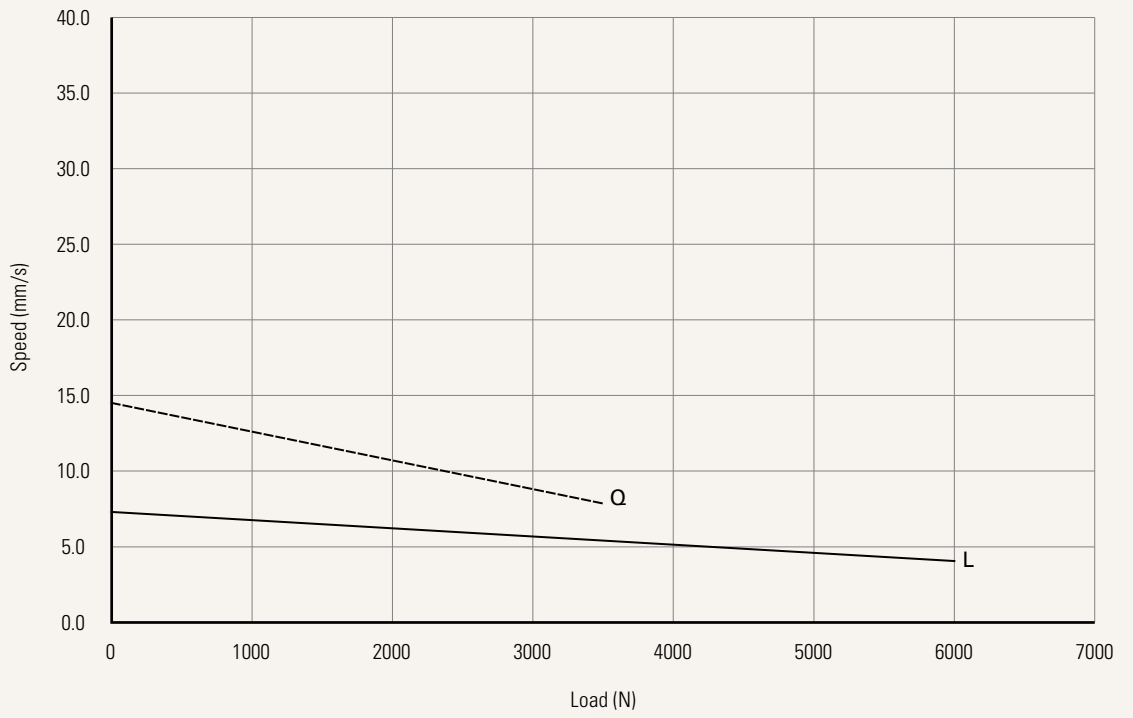

Current vs. Load

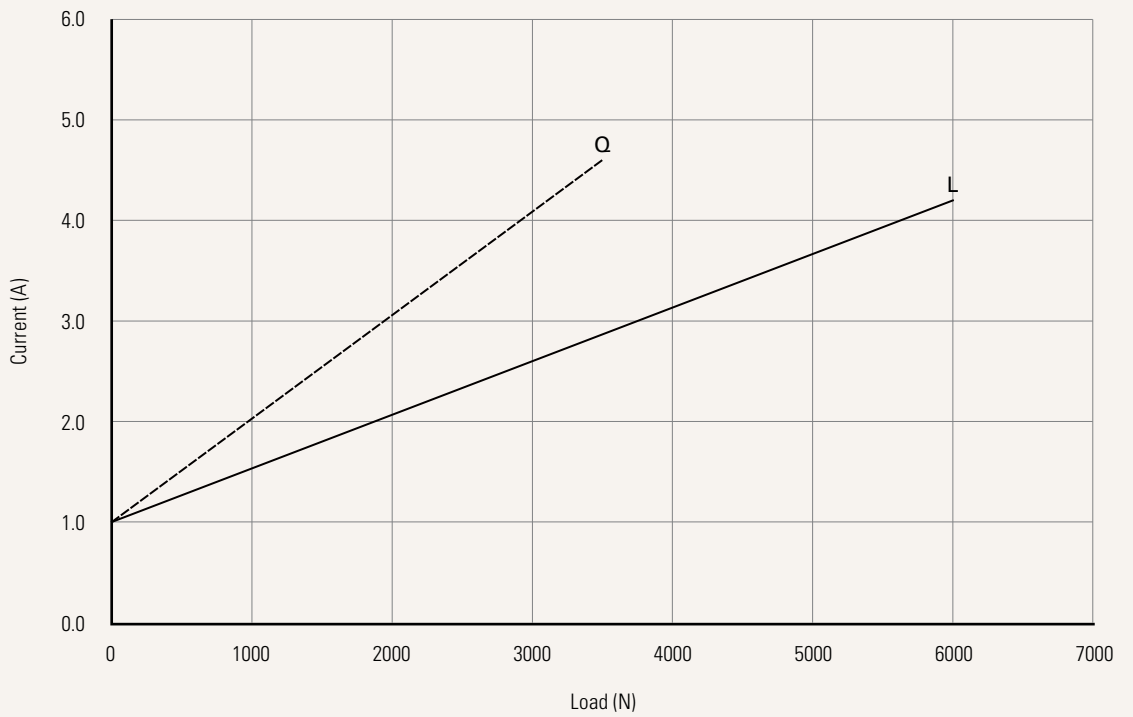

Voltage	1 = 12V DC	2 = 24V DC	3 = 36V DC	5 = 24V DC, PTC
Load and Speed	See page 2			
Stroke (mm)	See page 6			
Retracted Length (mm)	See page 6			
Rear Attachment (mm)	1 = Aluminum CNC, without slot, hole 10.2, for hand crank 2 = Aluminum CNC, without slot, hole 12.2, for hand crank See page 7			
Front Attachment (mm)	1 = Casting, width 32, hole 10.2		2 = Casting, width 32, hole 12.2 See page 7	
Direction of Rear Attachment (Counterclockwise)	1 = 0°		2 = 90° See page 7	
Color	1 = Black		2 = Pantone 428C	
IP Rating	1 = Without		2 = IP54 3 = IP66	
Functions for Limit Switches	1 = Two switches at full retracted / extended positions to cut current 2 = Two switches at the retracted / extended positions to cut current with the third one in between to send signal 3 = Two switches at the retracted / extended positions to send signal 4 = Two switches at the retracted / extended positions and the third one in between to send signal See page 7			
Output Signal	0 = Without		1 = Hall sensor*1 2 = Hall sensor*2	
Connector	1 = DIN 6P, 90° plug		2 = Tinned leads 3 = Small 01P, plug 4 = Big 01P, plug See page 8	
Cable Length (mm)	0 = Straight, 100 1 = Straight, 500 2 = Straight, 750		3 = Straight, 1000 4 = Straight, 1250 5 = Straight, 1500 6 = Straight, 2000 7 = Curly, 200 8 = Curly, 400	
Brake	0 = Without			

Retracted Length (mm)

1. Calculate $A = Y$
 2. Retracted length needs to $\geq \text{Stroke} + Y$
- *Retracted length : $S + 188$

B.

Stroke (mm)	Load (N)	
	General	
	< 6000	= 6000
25~150	-	-
151~200	-	-
201~250	-	+5
251~300	-	+10
301~350	+5	+15
351~400	+10	+20
401~450	+15	+25
451~500	+20	+30
501~550	+25	+35
551~600	+30	+40
601~650	+35	x
651~700	+40	x
701~750	+45	x
751~800	+50	x
801~850	+55	x
851~900	+60	x
901~950	+65	x
951~1000	+70	x

Rear Attachment (mm)

1 = Aluminum CNC, without slot, hole 10.2, for hand crank

2 = Aluminum CNC, without slot, hole 12.2, for hand crank

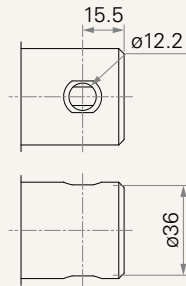
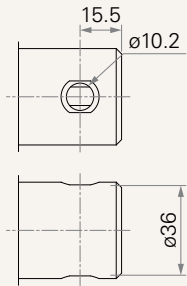

Front Attachment (mm)

1 = Casting, width 32, hole 10.2

2 = Casting, width 32, hole 12.2

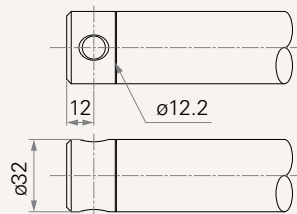
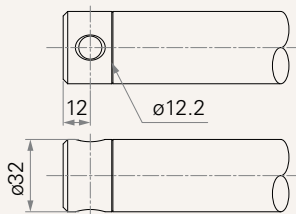

Direction of Rear Attachment (Counterclockwise)

1 = 0°

2 = 90°

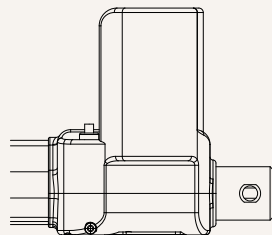
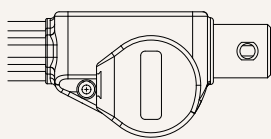

Functions for Limit Switches

Wire Definitions

CODE	Pin					
	1 (Green)	2 (Red)	3 (White)	4 (Black)	5 (Yellow)	6 (Blue)
1	extend (VDC+)	N/A	N/A	N/A	retract (VDC+)	N/A
2	extend (VDC+)	N/A	middle switch pin B	middle switch pin A	retract (VDC+)	N/A
3	extend (VDC+)	common	upper limit switch	N/A	retract (VDC+)	lower limit switch
4	extend (VDC+)	common	upper limit switch	medium limit switch	retract (VDC+)	lower limit switch

Connector

1 = DIN 6P, 90° plug

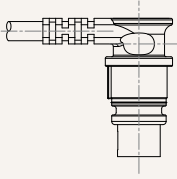

2 = Tinned leads

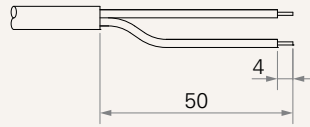

4 = Big 01P, plug

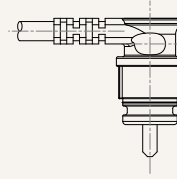

Terms of Use

The user is responsible for determining the suitability of TiMOTION products for a specific application. TiMOTION products are subject to change without prior notice.